

SUN2000-(330KTL-H1, 330KTL-H2)

User Manual

Issue Draft A
Date 2022-08-30



Copyright © Huawei Technologies Co., Ltd. 2022. All rights reserved.

No part of this document may be reproduced or transmitted in any form or by any means without prior written consent of Huawei Technologies Co., Ltd.

Trademarks and Permissions



HUAWEI and other Huawei trademarks are trademarks of Huawei Technologies Co., Ltd.

All other trademarks and trade names mentioned in this document are the property of their respective holders.

Notice

The purchased products, services and features are stipulated by the contract made between Huawei and the customer. All or part of the products, services and features described in this document may not be within the purchase scope or the usage scope. Unless otherwise specified in the contract, all statements, information, and recommendations in this document are provided "AS IS" without warranties, guarantees or representations of any kind, either express or implied.

The information in this document is subject to change without notice. Every effort has been made in the preparation of this document to ensure accuracy of the contents, but all statements, information, and recommendations in this document do not constitute a warranty of any kind, express or implied.

Huawei Technologies Co., Ltd.

Address: Huawei Industrial Base
Bantian, Longgang
Shenzhen 518129
People's Republic of China

Website: <https://e.huawei.com>

About This Document

Purpose

This document describes the SUN2000-330KTL-H1 and SUN2000-330KTL-H2 (also referred to as SUN2000) in terms of installation, commissioning, maintenance, and troubleshooting. Before installing and operating the SUN2000, ensure that you are familiar with the features, functions, and safety precautions provided in this document.





Figures provided in this document are for reference only.

Intended Audience

This document is intended for photovoltaic (PV) plant operating personnel and qualified electricians.

Symbol Conventions

The symbols that may be found in this document are defined as follows.

| Symbol | Description |
|---|---|
|  | Indicates a hazard with a high level of risk which, if not avoided, will result in death or serious injury. |
|  | Indicates a hazard with a medium level of risk which, if not avoided, could result in death or serious injury. |
|  | Indicates a hazard with a low level of risk which, if not avoided, could result in minor or moderate injury. |
|  | Indicates a potentially hazardous situation which, if not avoided, could result in equipment damage, data loss, performance deterioration, or unanticipated results. NOTICE is used to address practices not related to personal injury. |

| Symbol | Description |
|--|--|
|  NOTE | Supplements the important information in the main text. NOTE is used to address information not related to personal injury, equipment damage, and environment deterioration. |

Change History

| Issue | Date | Description |
|---------|------------|--|
| Draft A | 2022-08-30 | This issue is used for first office application (FOA). |

Contents

| | |
|---|-----------|
| About This Document..... | ii |
| 1 Safety Information..... | 1 |
| 1.1 Personal Safety..... | 2 |
| 1.2 Electrical Safety..... | 4 |
| 1.3 Environment Requirements..... | 6 |
| 1.4 Mechanical Safety..... | 8 |
| 2 Overview..... | 12 |
| 2.1 Product Models..... | 12 |
| 2.2 Product Introduction..... | 13 |
| 2.3 Enclosure Labels..... | 14 |
| 2.4 Component Description..... | 15 |
| 2.4.1 Product Appearance..... | 16 |
| 2.4.2 Indicator Status..... | 18 |
| 2.5 Working Principles..... | 20 |
| 2.5.1 Circuit Diagram..... | 20 |
| 2.5.2 Working Modes..... | 20 |
| 3 Storage..... | 22 |
| 4 Installation..... | 24 |
| 4.1 Checking Before Installation..... | 24 |
| 4.2 Preparing Tools..... | 24 |
| 4.3 Determining the Installation Position..... | 27 |
| 4.4 Installing the Mounting Bracket..... | 30 |
| 4.5 Installing the SUN2000..... | 31 |
| 5 Installing Cables..... | 33 |
| 5.1 Precautions..... | 33 |
| 5.2 Preparing Cables..... | 33 |
| 5.3 Crimping an OT or DT Terminal..... | 38 |
| 5.4 Installing PE Cables and AC Power Cables..... | 41 |
| 5.5 Installing DC Power Cables..... | 46 |
| 5.6 Installing Communications Cables..... | 50 |
| 6 Power-On Commissioning..... | 52 |

| | |
|--|-----------|
| 6.1 Check Before Power-On..... | 52 |
| 6.2 System Power-On..... | 53 |
| 7 Man-Machine Interactions..... | 55 |
| 7.1 Operations with the App..... | 55 |
| 7.1.1 App Introduction..... | 55 |
| 7.1.2 Downloading and Installing the App..... | 56 |
| 7.1.3 Logging In to the App..... | 57 |
| 7.2 Upgrading the SUN2000 Using a USB Flash Drive..... | 60 |
| 8 Maintenance..... | 62 |
| 8.1 Shutdown and Power-Off..... | 62 |
| 8.2 Power-Off for Maintenance..... | 62 |
| 8.3 Routine Maintenance..... | 64 |
| 8.4 Replacing a Fan..... | 66 |
| 8.5 Troubleshooting..... | 69 |
| 9 Handling the Inverter..... | 79 |
| 9.1 Removing the SUN2000..... | 79 |
| 9.2 Packing the SUN2000..... | 79 |
| 9.3 Disposing of the SUN2000..... | 79 |
| 10 Technical Specifications..... | 80 |
| A Domain Name List of Management Systems..... | 83 |
| B Contact Information..... | 84 |
| C Acronyms and Abbreviations..... | 86 |

1 Safety Information

Statement

Before installing, operating, or maintaining the equipment, read this document, strictly follow the instructions provided herein, and follow all the safety instructions on the equipment and in this document.

The **DANGER, WARNING, CAUTION**, and **NOTICE** statements in this document do not cover all the safety instructions. They are only supplements to the safety instructions. The Company will not be liable for any consequences that may arise due to violations of general safety requirements or safety standards concerning the design, production, and usage of the equipment.

Ensure that the equipment is used in environments that meet its design specifications. Otherwise, the equipment may become faulty, and any resulting malfunction, component damage, personal injury, or property damage will not be covered under the warranty.

Comply with local laws and regulations during transportation, storage, installation, operation, and maintenance.

Do not perform reverse engineering, decompilation, disassembly, adaptation, implantation, or other derivative operations on the equipment software. Do not study the internal implementation logic of the equipment, obtain the source code of the equipment software, steal intellectual property rights, or disclose any of the performance test results of the equipment software.

The Company will not be liable for any consequences in any of the following circumstances:

- Equipment damage due to force majeure (such as earthquakes, floods, volcanic eruptions, debris flows, lightning strikes, fires, and wars)
- Operation beyond the conditions specified in this document
- Installation or use in environments which are not specified in relevant international, national, or regional standards
- Failure to follow the operation instructions or safety precautions on the product or in this document
- Unauthorized modifications to the product or software code or removal of the product

- Damage caused during transportation by the customer or a third party authorized by the customer
- Storage conditions that do not meet the requirements specified in this document
- Failure to comply with local laws, regulations, and related standards due to the materials and tools prepared by the customer
- Damage caused by the customer's negligence or improper operations or third-party reasons
- Defects, malfunctions or damage caused by acts, events, negligence, or accidents beyond the Company's reasonable control, including power outages or electrical failures, theft, wars, riots, civil disturbances, terrorism, and intentional or malicious damage, etc.

1.1 Personal Safety

 **DANGER**

Ensure that power is off during installation. Do not install or remove a cable with power on. Transient contact between the core of the cable and the conductor will generate electric arcs or sparks, which may cause a fire or personal injury.

 **DANGER**

Non-standard and improper operations on the energized equipment may cause fire or electric shocks, resulting in property damage, personal injury, or even death.

 **DANGER**

Before operations, remove conductive objects such as watches, bracelets, bangles, rings, and necklaces to prevent electric shocks.

 **DANGER**

During operations, use dedicated insulated tools to prevent electric shocks or short circuits. The insulation and voltage resistance must comply with local laws and regulations and IEC 62477-1/-2 or GB 311.

 **WARNING**

During operations, wear personal protective equipment such as protective clothing, insulated shoes, goggles, safety helmets, and insulated gloves.

General Requirements

- Do not stop protective devices. Pay attention to the warnings, cautions, and related precautionary measures in this document and on the equipment.
- If there is a likelihood of personal injury or equipment damage during operations, immediately stop, report the case to the supervisor, and take feasible protective measures.
- Do not power on the equipment before it is installed or commissioned by professionals.
- Do not touch the power supply equipment directly or with conductors such as damp objects. Before touching any conductor surface or terminal, measure the voltage at the contact point to ensure that there is no risk of electric shock.
- Do not touch operating equipment because the enclosure is hot.
- Do not touch a running fan with your hands, components, screws, tools, or boards. Otherwise, personal injury or equipment damage may occur.
- In the case of a fire, immediately leave the building or the equipment area and activate the fire alarm or call emergency services. Do not enter the building on fire in any case.

Personnel Requirements

- Only professionals and trained personnel are allowed to operate the equipment.
 - Professionals: personnel who are familiar with the working principles and structure of the equipment, trained or experienced in equipment operations and are clear of the sources and degree of various potential hazards in equipment installation, operation, maintenance
 - Trained personnel: personnel who are trained in technology and safety, have required experience, are aware of possible hazards on themselves in certain operations, and are able to take protective measures to minimize the hazards on themselves and other people
- Personnel who plan to install or maintain the equipment must receive adequate training, be able to correctly perform all operations, and understand all necessary safety precautions and local relevant standards.
- Only qualified professionals or trained personnel are allowed to install, operate, and maintain the equipment.
- Only qualified professionals are allowed to remove safety facilities and inspect the equipment.
- Personnel who will perform special tasks such as electrical operations, working at heights, and operations of special equipment should possess the required local qualifications.
- Only authorized professionals are allowed to replace the equipment or components (including software).
- Only personnel who need to work on the equipment are allowed to access the equipment.

1.2 Electrical Safety

 **DANGER**

Non-standard and improper operations may result in fire or electric shocks.

 **DANGER**

Prevent foreign matter from entering the equipment during operations. Otherwise, equipment damage, load power derating, power failure, or personal injury may occur.

 **WARNING**

For the equipment that needs to be grounded, install the ground cable first when installing the equipment and remove the ground cable last when removing the equipment.

 **CAUTION**

Do not route cables behind the air intake and exhaust vents of the equipment.

General Requirements

- Installation, operation, and maintenance must be performed in the sequence specified in the manual. Do not change the structure or installation sequence of the equipment without permission.
- Obtain approval from the national or local electric utility company before connecting the equipment to the grid.
- Observe the power plant safety regulations, such as the operation and work ticket mechanisms.
- Before performing operations on the equipment, check that all tools meet the requirements and record the tools. After the operations are complete, collect all of the tools to prevent them from being left inside the equipment.
- Before connecting power cables, check that cable labels are correct and cable terminals are insulated.
- When installing the equipment, use a torque tool of a proper measurement range to tighten the screws. When using a wrench to tighten the screws, ensure that the wrench does not tilt and the torque error does not exceed 10% of the specified value.

- Ensure that bolts are tightened with a torque tool and marked in red and blue after double-check. Installation personnel mark tightened bolts in blue. Quality inspection personnel confirm that the bolts are tightened and then mark them in red. (The marks should cross the edges of the bolts.)

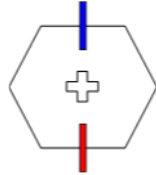

- If the equipment has multiple inputs, disconnect all the inputs before operating the equipment.
- Before maintaining a downstream electrical device supply or power distribution device, turn off the output switch of its power supply equipment.
- During equipment maintenance, attach "Do not switch on" labels near the upstream and downstream switches or circuit breakers as well as warning signs to prevent accidental connection. The equipment can be powered on only after troubleshooting is complete.
- Do not open equipment panels.
- Check equipment connections periodically, ensuring that all screws are securely tightened.
- A damaged cable must be replaced by the manufacturer or professionals to avoid risks.
- Do not scrawl, damage, or block any labels or nameplates on the equipment. Promptly replace labels that have worn out.
- Do not use solvents such as water, alcohol, or oil to clean electrical components inside or outside of the equipment.

Grounding

- Ensure that the grounding impedance of the equipment complies with local electrical standards.
- Ensure that the equipment is connected permanently to the protective ground. Before operating the equipment, check its electrical connection to ensure that it is reliably grounded.
- Do not work on the equipment in the absence of a properly installed ground conductor.
- Do not damage the ground conductor.

Cabling Requirements

- When selecting, installing, and routing cables, follow local safety regulations and rules.
- When routing power cables, ensure that there is no coiling or twisting. Do not join or weld power cables. If necessary, use a longer cable.
- Ensure that all cables are properly connected and insulated, and meet specifications.
- Ensure that the slots and holes for routing cables are free from sharp edges, and that the positions where cables are routed through pipes or cable holes

are equipped with cushion materials to prevent the cables from being damaged by sharp edges or burrs.

- Ensure that all cables are securely bound. Route and bind cables so that they appear neat and tidy and their cable sheaths are intact.
- After connecting cables, secure them using cable supports and cable clips. Ensure that the cables in the backfill area are in close contact with the ground to prevent cable deformation or damage during backfilling.
- If the external conditions (such as the cable layout or ambient temperature) change, verify the cable usage in accordance with the IEC-60364-5-52 or local laws and regulations. For example, check that the current-carrying capacity meets requirements.
- When the temperature is low, violent impact or vibration may damage the plastic cable sheathing. To ensure safety, comply with the following requirements:
 - Cables can be laid or installed only when the temperature is higher than 0°C. Handle cables with caution, especially at a low temperature.
 - Cables stored at subzero temperatures must be stored at room temperature for at least 24 hours before they are laid out.
- Do not perform any improper operations, for example, dropping cables directly from a vehicle. Otherwise, the cable performance may deteriorate due to cable damage, which affects the current-carrying capacity and temperature rise.

1.3 Environment Requirements

DANGER

Do not expose the equipment to flammable or explosive gas or smoke. Do not perform any operation on the equipment in such environments.

DANGER

Do not place the equipment near heat sources or fire sources, such as smoke, candles, heaters, or other heating devices. Overheat may damage the equipment or cause a fire.

WARNING

Install the equipment in an area far away from liquids. Do not install it under areas prone to condensation, such as under water pipes and air exhaust vents, or areas prone to water leakage, such as air conditioner vents, ventilation vents, or feeder windows of the equipment room. Ensure that no liquid enters the equipment to prevent faults or short circuits.

 **WARNING**

- To prevent damage or fire due to high temperature, ensure that the ventilation vents or heat dissipation systems are not obstructed or covered by other objects while the equipment is running.
-

General Requirements

- Ensure that the equipment is stored in a clean, dry, and well ventilated area with proper temperature and humidity and is protected from dust and condensation.
- Do not install or run the equipment beyond the technical specifications. Otherwise, its performance and safety will be compromised.
- Do not install, use, or operate outdoor equipment and cables (including but not limited to moving equipment, operating equipment and cables, inserting connectors to or removing connectors from signal ports connected to outdoor facilities, working at heights, performing outdoor installation, and opening doors) in harsh weather conditions such as lightning, rain, snow, and level 6 or stronger wind.
- Do not install the equipment in an environment with direct sunlight, dust, smoke, volatile or corrosive gases, infrared and other radiations, organic solvents, or salty air.
- Do not install the equipment in an environment with conductive metal or magnetic dust.
- Do not install the equipment in an area conducive for the growth of microorganisms such as fungus or mildew.
- Do not install the equipment in an area with strong vibration, noise, or electromagnetic interference.
- Ensure that the ground in the installation environment is solid, free from spongy or soft soil, and not prone to subsidence. The site must not be located in a low-lying land or an area prone to water accumulation, and the horizontal level of the site must be above the highest water level of that area in history.
- Before opening doors during the installation, operation, and maintenance of the equipment, clean up any water, ice, snow, or other foreign objects on the top of the equipment to prevent foreign objects from falling into the equipment.
- When installing the equipment, ensure that the installation surface is solid enough to bear the weight of the equipment.
- After installing the equipment, remove the packing materials such as cartons, foam, plastics, and cable ties from the equipment area.

1.4 Mechanical Safety

WARNING

Ensure that all necessary tools are ready and inspected by a professional organization. Do not use tools that have signs of scratches or fail to pass the inspection or whose inspection validity period has expired.

WARNING

Do not drill holes into the equipment. Doing so may affect the sealing performance and electromagnetic containment of the equipment and damage components or cables inside. Metal shavings from drilling may short-circuit boards inside the equipment.

General Requirements

- Repaint any scratched surfaces caused during equipment transportation or installation in a timely manner. Scratched equipment should not be exposed to an outdoor environment for an extended period of time.
- Do not perform operations such as arc welding and cutting on the equipment without evaluation by the Company.
- Do not install other devices on the top of the equipment without evaluation by the Company.
- When performing operations (such as hoisting or installing an awning) over the top of the equipment, take measures to protect the equipment against damage.
- Use correct tools and operate them in the correct way.

Moving Heavy Objects

- Be cautious to prevent injury when moving heavy objects.

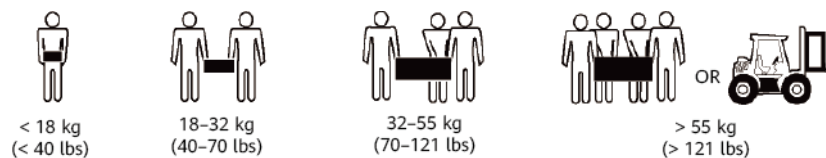

- If multiple persons need to move a heavy object together, determine the manpower and work division with consideration of height and other conditions to ensure that the weight is equally distributed.
- If two persons or more move a heavy object together, ensure that the object is lifted and landed simultaneously and moved at a uniform pace under the supervision of one person.
- Wear personal protective gears such as protective gloves and shoes when manually moving the equipment.

- To move an object by hand, approach to the object, squat down, and then lift the object gently and stably by the force of the legs instead of your back. Do not lift it suddenly or turn your body around.
- Do not quickly lift a heavy object above your waist. Place the object on a workbench that is half-waist high or any other appropriate place, adjust the positions of your palms, and then lift it.
- Move a heavy object stably with balanced force at an even and low speed. Put down the object stably and slowly to prevent any collision or drop from scratching the surface of the equipment or damaging the components and cables.
- When moving a heavy object, be aware of the workbench, slope, staircase, and slippery places. When moving a heavy object through a door, ensure that the door is wide enough to move the object and avoid bumping or injury.
- When transferring a heavy object, move your feet instead of turning your waist around. When lifting and transferring a heavy object, ensure that your feet point to the target direction of movement.
- When transporting the equipment using a pallet truck, ensure that the forks are properly positioned so that the equipment does not topple. Before moving the equipment, secure it to the pallet truck using ropes. When moving the equipment, assign dedicated personnel to take care of it.
- Choose sea or roads in good conditions for transportation as transportation by railway or air is not supported. Avoid tilt or jolt during transportation.

Using Ladders

- Use wooden or insulated ladders when you need to perform live-line working at heights.
- Platform ladders with protective rails are preferred. Single ladders are not recommended.
- Before using a ladder, check that it is intact and confirm its load bearing capacity. Do not overload it.
- Ensure that the ladder is securely positioned and held firm.
- When climbing up the ladder, keep your body stable and your center of gravity between the side rails, and do not overreach to the sides.
- When a step ladder is used, ensure that the pull ropes are secured.
- If a single ladder is used, the recommended angle for the ladder against the floor is 75 degrees, as shown in the following figure. A square can be used to measure the angle.

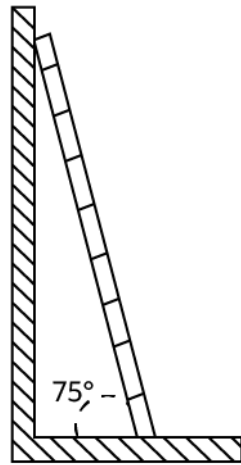

PI02SC0008

- If a single ladder is used, ensure that the wider end of the ladder is at the bottom, and take protective measures to prevent the ladder from sliding.
- If a single ladder is used, do not climb higher than the fourth rung of the ladder from the top.
- If you use a single ladder to climb up to a platform, ensure that the ladder is at least 1 m higher than the platform.

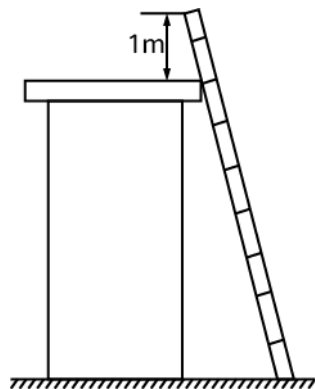

PI02SC0009

Hoisting

- Only trained and qualified personnel are allowed to perform hoisting operations.
- Install temporary warning signs or fences to isolate the hoisting area.
- Ensure that the foundation where hoisting is performed on meets the load-bearing requirements.
- Before hoisting objects, ensure that hoisting tools are firmly secured onto a fixed object or wall that meets the load-bearing requirements.
- During hoisting, do not stand or walk under the crane or the hoisted objects.
- Do not drag steel ropes and hoisting tools or bump the hoisted objects against hard objects during hoisting.
- Ensure that the angle between two hoisting ropes is no more than 90 degrees, as shown in the following figure.

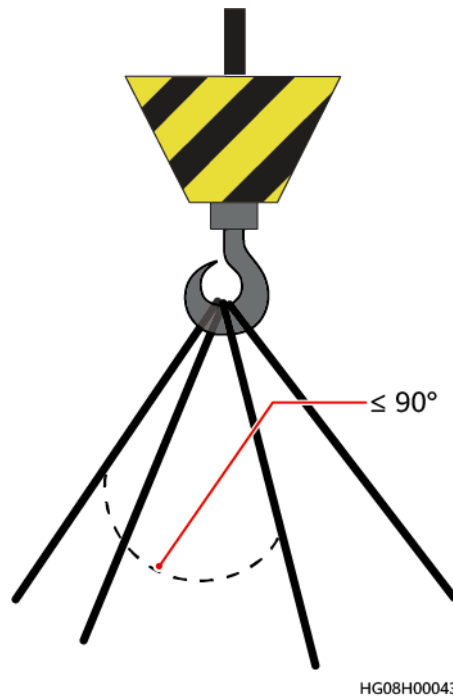

Drilling Holes

- A welder must have a work permit. Obtain consent from the customer before welding.
- Wear protective equipment such as safety goggles and protective gloves when drilling holes.
- To avoid short circuits or other risks, do not drill holes into buried pipes or cables.
- When drilling holes, protect the equipment from shavings. After drilling, clean up any shavings.

2 Overview

2.1 Product Models

Model Number Description

This document involves the following product models:

- SUN2000-330KTL-H1
- SUN2000-330KTL-H2

Figure 2-1 Model number

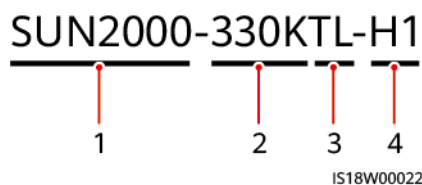

| No. | Item | Description |
|-----|-------------|--|
| 1 | Series name | SUN2000: grid-tied solar inverter |
| 2 | Power | 330K: The power level is 330 kW. |
| 3 | Topology | TL: transformerless |
| 4 | Design code | H1/H2: product series with the 1500 V DC input voltage |

Model Identification

You can obtain the inverter model from the model label on the external package and the nameplate on the side of the enclosure.

Figure 2-2 Position of the model label on the external package

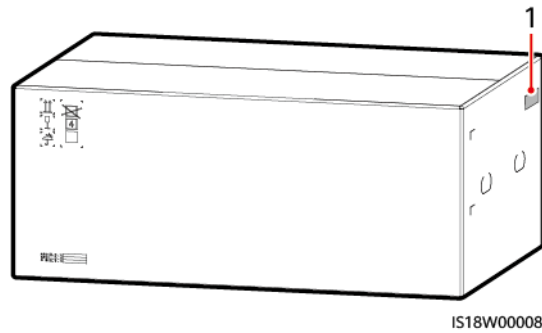

(1) Position of the model label

2.2 Product Introduction

Function

The SUN2000 is a three-phase grid-tied PV string inverter that converts the DC power generated by PV strings into AC power and feeds the power into the power grid.

Networking Application

The SUN2000 applies to grid-tied PV systems for commercial rooftops and large power plants. Typically, a grid-tied PV system consists of the PV strings, inverter, AC power distribution unit, and step-up transformer.

Figure 2-3 Networking application

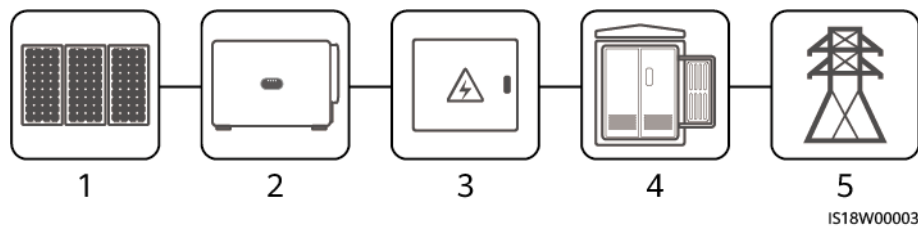

(1) PV string

(2) SUN2000

(3) AC power distribution unit

(4) Step-up transformer

(5) Power grid

NOTE

Connect the SUN2000 to a dedicated power transformer instead of a low-voltage overhead power cable.

Power Grid Type



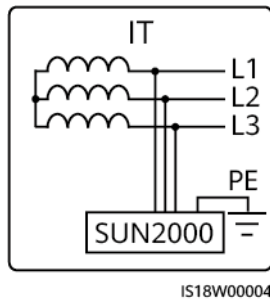

The SUN2000 supports IT power grids

Figure 2-4 Power grid type

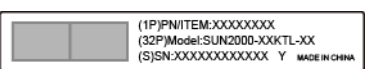

2.3 Enclosure Labels

| Symbol | Name | Meaning |
|--------|------------------------|---|
| | Operation warning | Potential hazards exist after the SUN2000 is powered on. Take protective measures when operating the SUN2000. |
| | Burn warning | Do not touch the SUN2000 when it is running because its enclosure is hot. |
| | Large current warning | Before powering on the SUN2000, ensure that the SUN2000 is grounded because there is a large contact current after the SUN2000 is powered on. |
| | Delayed discharge | <ul style="list-style-type: none"> High voltage exists after the SUN2000 is powered on. Only qualified and trained electrical technicians are allowed to perform operations on the SUN2000. Residual voltage exists after the SUN2000 is powered off. It takes 15 minutes for the SUN2000 to discharge to the safe voltage. |
| | Refer to documentation | Reminds operators to refer to the documents delivered with the SUN2000. |
| | Grounding | Indicates the position for connecting the ground cable. |

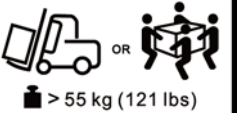
| Symbol | Name | Meaning |
|---|-------------------------|---|
|  <p>Do not disconnect under load! 禁止带负荷断开连接!</p> | Operation warning | Do not remove the DC input connector when the SUN2000 is running. |
|  | Fan operation warning | High voltage exists after the SUN2000 is powered on. Do not touch the fans when the SUN2000 is working. |
|  <p>CAUTION Before replacing the fan, disconnect the FAN-POWER cable and then the fan cable. 更换风扇前，必须先拔掉风扇电源线，再拔掉风扇线。</p> | Fan replacement warning | The power connector of the fan must be disconnected before fan replacement. |
|  | SUN2000 ESN label | Indicates the SUN2000 serial number. |
|   | Weight label | The SUN2000 needs to be carried by four persons or using a forklift. |

2.4 Component Description

2.4.1 Product Appearance

Appearance

Figure 2-5 Appearance

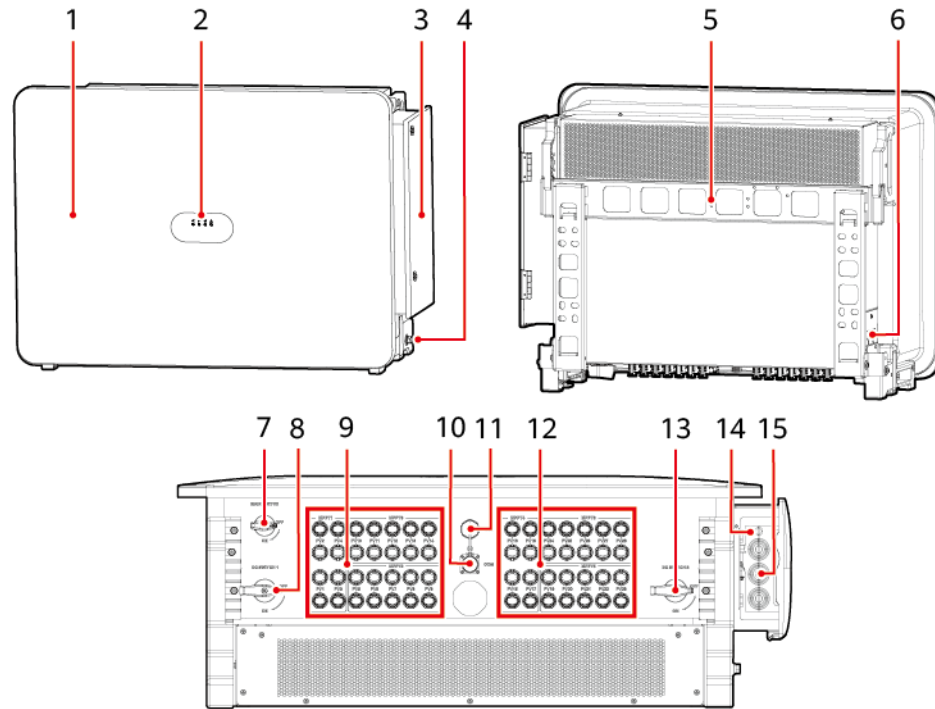

IS18W00005

- | | |
|---|---|
| (1) Panel | (2) LED indicators |
| (3) Maintenance compartment door | (4) Ground point on the enclosure |
| (5) Mounting bracket | (6) Fan tray |
| (7) Main switch (MAIN SWITCH) | (8) DC switch 1 (DC SWITCH 1) |
| (9) DC input terminal group 1 (PV1–PV14, controlled by DC SWITCH 1) | (10) RS485 communications port (COM) |
| (11) USB port (USB) | (12) DC input terminal group 2 (PV15–PV28, controlled by DC SWITCH 2) |
| (13) DC switch 2 (DC SWITCH 2) | (14) Tracking system power cable hole |
| (15) AC output power cable holes | |

Dimensions

Figure 2-6 Dimensions

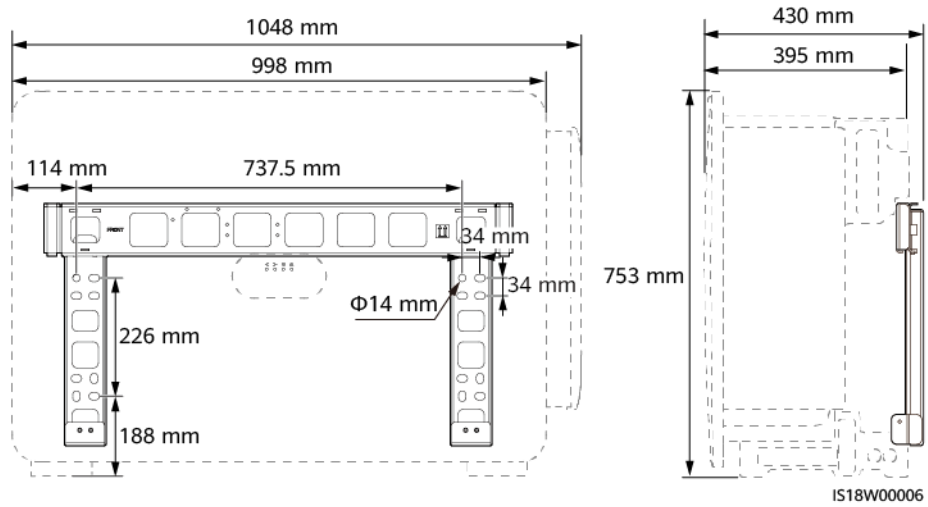





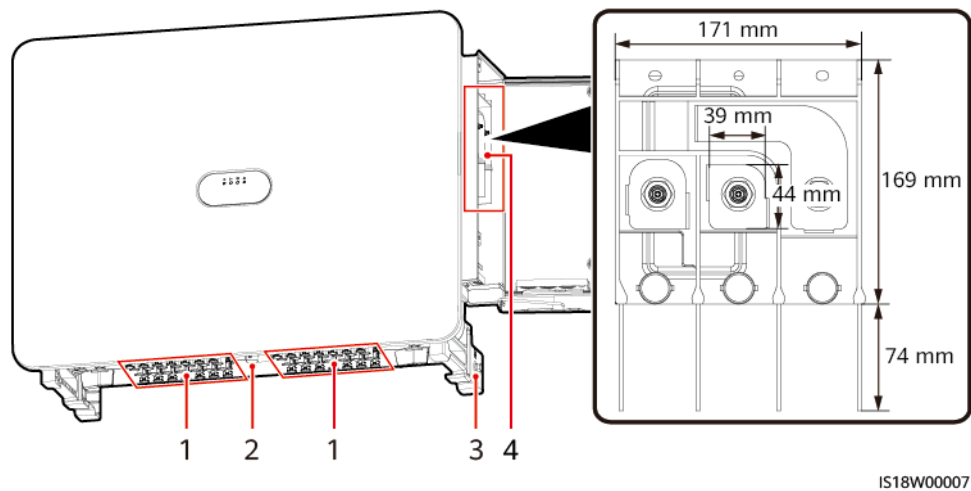



Wiring Area

Figure 2-7 Wiring ports



- (1) DC input terminals
- (2) RS485 communications port
- (3) Ground point on the enclosure
- (4) AC terminal block

2.4.2 Indicator Status

| Indicator | Status (Blinking Fast: On for 0.2s and Off for 0.2s; Blinking Slowly: On for 1s and Off for 1s) | Meaning |
|---|---|---|
| PV connection indicator   | Steady green | At least one PV string is properly connected, and the DC input voltage of the corresponding MPPT circuit is higher than or equal to 500 V. |
| | Blinking green fast | If the alarm/maintenance indicator is red, an environmental fault at the DC side of the SUN2000 was generated. |
| | Off | The SUN2000 disconnects from all PV strings, or the DC input voltages of all MPPT circuits are less than 500 V. |
| Grid connection indicator   | Steady green | The SUN2000 is in grid-tied mode. |
| | Blinking green fast | If the alarm/maintenance indicator is red, an environmental fault at the AC side of the SUN2000 was generated. |
| | Off | The SUN2000 is not in grid-tied mode. |
| Communication indicator   | Blinking green fast | The SUN2000 receives communication data normally. |
| | Off | The SUN2000 has not received communication data for 10 seconds. |
| Alarm/Maintenance indicator   | Alarm state | A major alarm is generated. |
| | | <ul style="list-style-type: none"> If the PV connection indicator or grid-connection indicator is blinking green fast, troubleshoot DC or AC environmental faults as instructed by the app. If the PV connection indicator and grid connection indicator are both not blinking green fast, replace components or the device as instructed by the app. |
| | | A minor alarm was generated. |
| | A warning alarm was generated. | |
| | Local maintenance state | The local maintenance is successful. |
| | | Local maintenance failed. |
| The device is under local maintenance or shut down after receiving a command. | | |

NOTE

- The PV connection indicator and the grid connection indicator preferentially indicate environmental faults.
- Local maintenance refers to operations performed after a USB flash drive, WLAN module, or USB data cable is inserted into the USB port of the SUN2000. For example, import and export data using a USB flash drive, or connect to the app using a WLAN module or USB data cable.
- If the alarming and the local maintenance happen concurrently, the alarm/maintenance indicator shows the local maintenance state first. After the USB flash drive, WLAN module, or USB data cable is removed, the indicator shows the alarm state.

2.5 Working Principles

2.5.1 Circuit Diagram

The SUN2000 receives inputs from 28 PV strings. The inputs are grouped into 6 MPPT circuits inside the SUN2000 to track the maximum power point of the PV strings. The DC power is converted into three-phase AC power through an inverter circuit. Surge protection is supported on both the DC and AC sides.

Figure 2-8 Schematic diagram

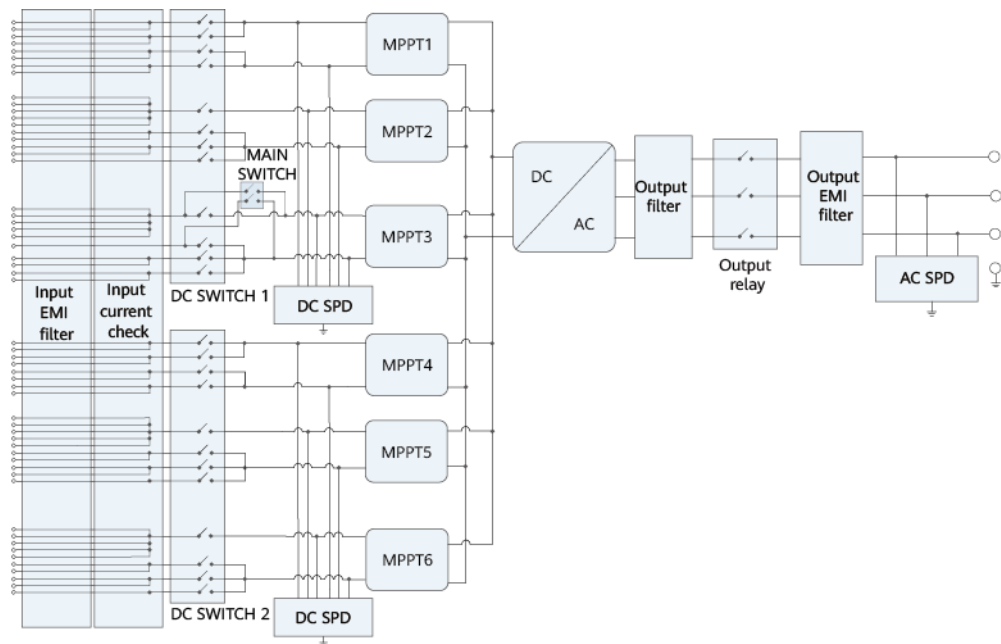

IS18W00009

2.5.2 Working Modes

The SUN2000 can work in Standby, Operating, or Shutdown mode.

Figure 2-9 Working modes

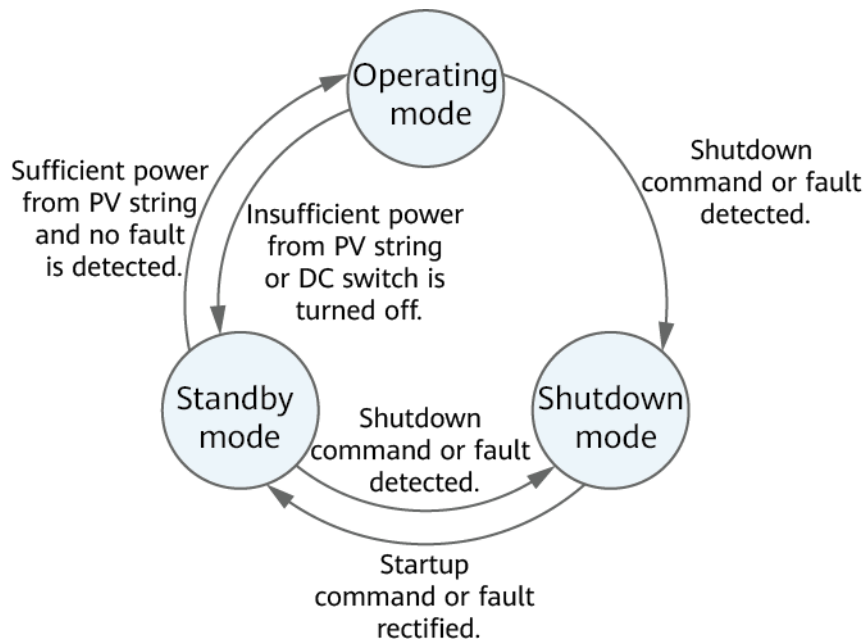

IS07500001

Table 2-1 Working mode description

| Working Mode | Description |
|--------------|--|
| Standby | <p>The SUN2000 enters Standby mode when the external environment does not meet the operating requirements. In Standby mode:</p> <ul style="list-style-type: none"> • The SUN2000 continuously performs status check and enters the Operating mode once the operating requirements are met. • The SUN2000 enters Shutdown mode after detecting a shutdown command or a fault after startup. |
| Operating | <p>In Operating mode:</p> <ul style="list-style-type: none"> • The SUN2000 converts DC power from PV strings into AC power and feeds the power to the power grid. • The SUN2000 tracks the maximum power point to maximize the PV string output. • If the SUN2000 detects a fault or a shutdown command, it enters the Shutdown mode. • The SUN2000 enters Standby mode after detecting that the PV string output power is not suitable for connecting to the power grid for generating power. |
| Shutdown | <ul style="list-style-type: none"> • In Standby or Operating mode, the SUN2000 enters Shutdown mode after detecting a fault or shutdown command. • In Shutdown mode, the SUN2000 enters Standby mode after detecting a startup command or that the fault is rectified. |

3 Storage

The following requirements should be met if the solar inverter is not put into use immediately:

- Do not remove the packing materials, and check the packing materials regularly (recommended: every three months). If any rodent bites are found, replace the packing materials immediately. If the solar inverter is unpacked but not put into use immediately, put it inside the original package with the desiccant bag, and seal it using tape.
- The ambient temperature and humidity should be suitable for the storage. The air must not contain corrosive or flammable gases.

Figure 3-1 Storage temperature and humidity

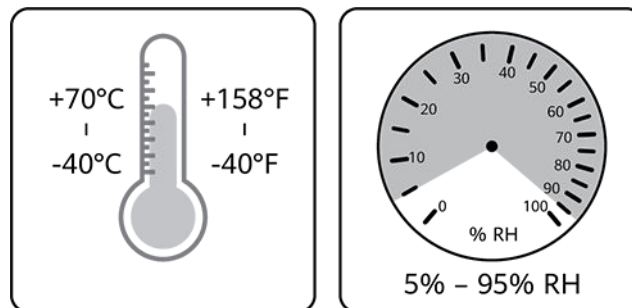

IS07W00011

- The solar inverter should be stored in a clean and dry place and be protected from dust and water vapor corrosion. The solar inverter must be protected against rain and water.
- Do not tilt the package or place it upside down.
- To avoid personal injury or device damage, stack inverters with caution to prevent them from falling over.

Figure 3-2 Maximum number of pile-up layers allowed

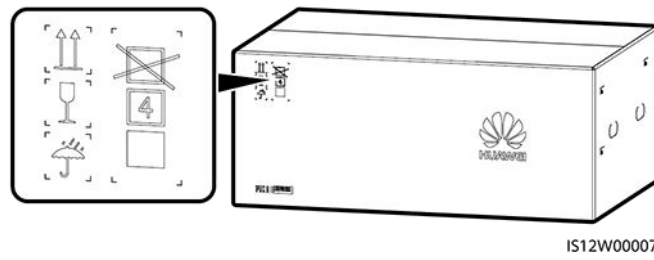

- If the solar inverter has been stored for more than two years, it must be checked and tested by professionals before being put into use.

4 Installation

4.1 Checking Before Installation

Outer Packing Materials

Before unpacking the inverter, check the outer packing materials for damage, such as holes and cracks, and check the inverter model. If any damage is found or the inverter model is not what you requested, do not unpack the package and contact your supplier as soon as possible.

 **NOTE**

You are advised to remove the packing materials within 24 hours before installing the inverter.

Package Contents





After unpacking the inverter, check that the contents are intact and complete. If any damage is found or any component is missing, contact your supplier.

 **NOTE**

For details about the number of contents, see the *Packing List* in the packing case.

4.2 Preparing Tools

Table 4-1 Personal protective equipment (PPE)

| | | | |
|---|---|--|---|
|  |  |  |  |
| Safety helmet | Goggles | Protective shoes | Reflective vest |





| | | | |
|---|---|--|---|
|  |  |  |  |
| Insulated gloves | Protective gloves | Dust mask | Insulated shoes |

Table 4-2 Hoisting and transporting tools





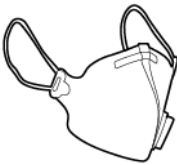

| | | | |
|---|---|--|---|
|  |  |  | - |
| Crane | Pallet truck | Lifting rope | |

Table 4-3 Hardware installation tools

| | | | |
|---|---|--|---|
|  |  |  |  |
| Flat-head insulated torque screwdriver (M3) | Phillips insulated torque screwdriver (M3/M4) | Insulated torque socket wrench (M4/M10/M12, including an extended socket) | Torx key |
|  |  |  |  |
| Hammer drill | Hammer drill bit (Φ14 mm) | Utility knife | Marker |

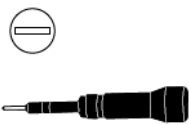
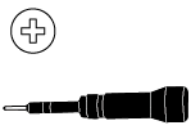
| | | | |
|---|---|---|---|
|  Insulated ladder | - | - | - |
|---|---|---|---|

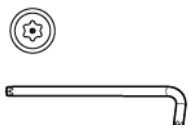
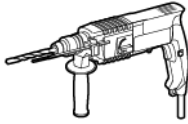
Table 4-4 Cable installation tools

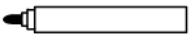

| | | | |
|---|---|---|---|
|  Cable cutter |  Wire strippers |  Diagonal pliers |  Hydraulic pliers |
|  Heat gun |  Crimping plier H4STC0001 or CT75A-FJB10 |  Removal wrench H4TW0001 | - |

Table 4-5 Measurement instruments





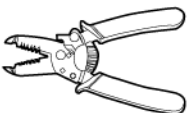
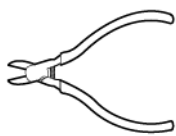
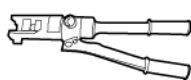

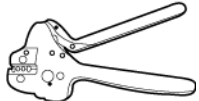
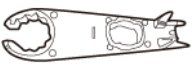

| | | | |
|--|--|---|---|
|  Clamp meter |  Steel measuring tape |  Level |  Multimeter DC voltage measurement range ≥ 1500 V DC |
|--|--|---|---|

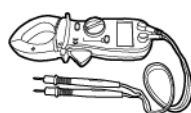
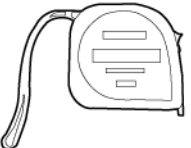
Table 4-6 Auxiliary materials and other tools

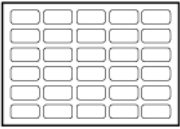
| | | | |
|---|--|--|---|
|  <p>Labels</p> |  <p>Cable tie</p> |  <p>Cotton cloth</p> |  <p>Sandpaper</p> |
|  <p>Heat-shrink tubing</p> |  <p>Insulation tape</p> |  <p>Brush</p> |  <p>Vacuum cleaner</p> |

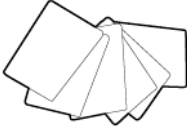
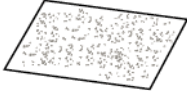
4.3 Determining the Installation Position

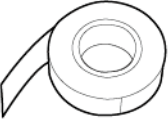
Installation Environment Requirements

- Do not install the inverter in working or living areas.
- If the device is installed in public places (such as parking lots, stations, and factories) other than working and living areas, install a protective net outside the device, set up a safety warning sign to isolate the device, and prevent unauthorized personnel from approaching the inverter. This is to avoid personal injury or property loss caused by accidental contact or other reasons during device operation.
- If inverters are installed in a place with abundant vegetation, in addition to routine weeding, harden the ground underneath the inverters using cement or gravel (recommended area: 3 m x 2.5 m).
- Do not install the inverter in areas with flammable materials.
- Do not install the inverter in areas with explosive materials.
- Do not install the inverter in areas with corrosive materials.
- Do not install the inverter where its enclosure and heat sinks are easily accessible, because the voltage is high and these parts are hot during operation.
- Install the inverter in a well-ventilated environment for heat dissipation
- If the inverter is installed in an airtight environment, a heat dissipation device or ventilation device must be installed to ensure that the indoor ambient temperature is not higher than the external ambient temperature during operation.
- You are advised to install the inverter in a sheltered place or install an awning over it.
- The inverter will be corroded in salt areas. Before installing the inverter outdoors in salt areas, consult Huawei. A salt area refers to the region within

500 meters from the coast or prone to sea breeze. The regions prone to sea breeze vary with weather conditions (such as typhoons and monsoons) or terrains (such as dams and hills).

Mounting Structure

- The mounting structure where the SUN2000 is installed must be fire resistant. Do not install the SUN2000 on flammable building materials.
- Ensure that the installation surface is solid enough to bear the weight of the SUN2000.

Installation Angle

The SUN2000 can be installed on a support. The installation angle requirements are as follows:

- Install the SUN2000 vertically or at a maximum back tilt of 75 degrees to facilitate heat dissipation.
- Do not install the SUN2000 at forward tilted, excessive back tilted, side tilted, horizontal, or upside down positions.

Figure 4-1 Installation angle

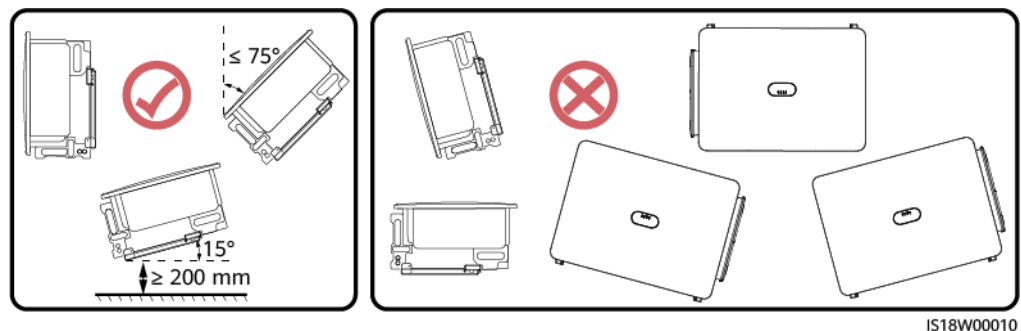

IS18W00010

Clearance

Reserve sufficient clearance around the SUN2000 for installation and heat dissipation.

Figure 4-2 Clearance

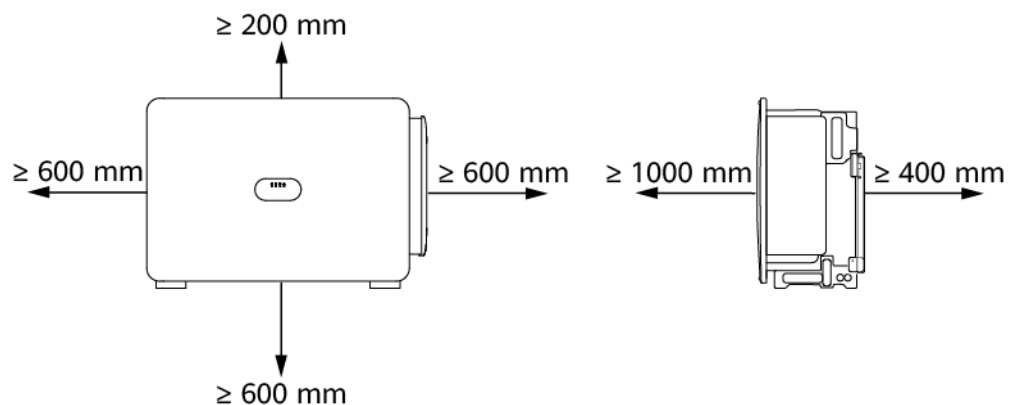

IS18W00019

 NOTE

- For ease of installing the SUN2000 on the mounting bracket, connecting cables to the bottom of the SUN2000, and maintaining the SUN2000 in future, it is recommended that the bottom clearance be between 600 mm and 730 mm. For further questions regarding clearance, consult local technical support engineers.
- The clearance at the bottom must meet the requirements on the bending radius of the AC output power cables.

If multiple SUN2000s need to be installed and the clearance is sufficient, install them in horizontal mode. The triangle, back-to-back, and close-to-wall installation modes are not recommended. For triangle, back-to-back, and close-to-wall installation modes, you need to prepare air baffles to isolate air intake from air exhaust.

Figure 4-3 Horizontal installation mode (recommended)

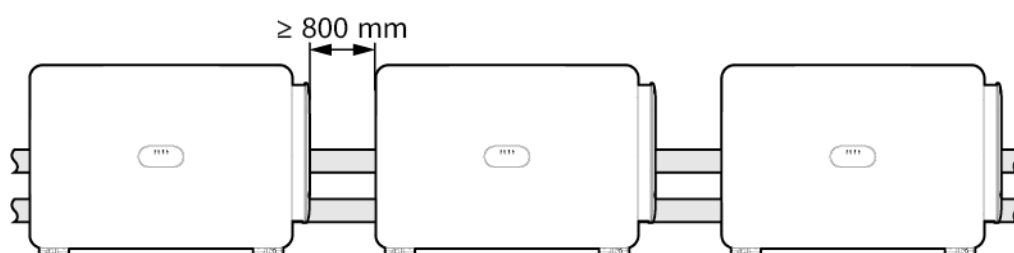

IS06W00046

Figure 4-4 Triangle installation mode (not recommended)

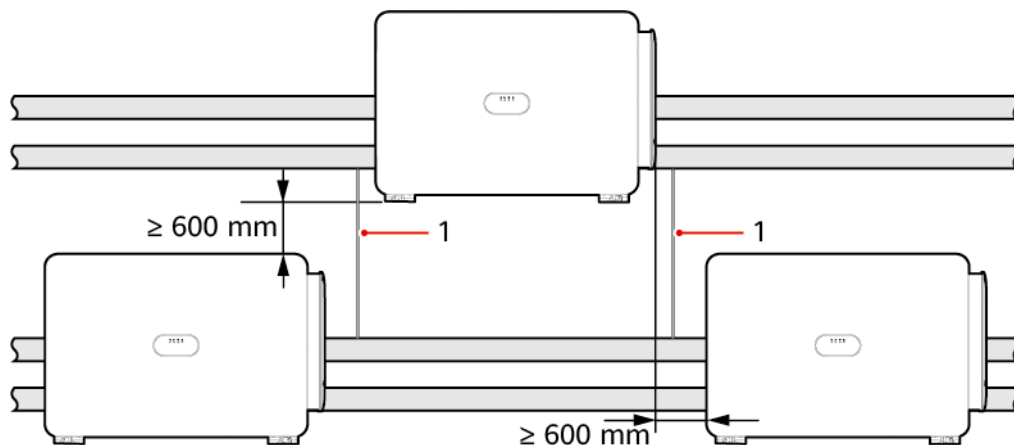

IS18W00013

(1) Air baffle

Figure 4-5 Back-to-back and close-to-wall installation modes (not recommended)

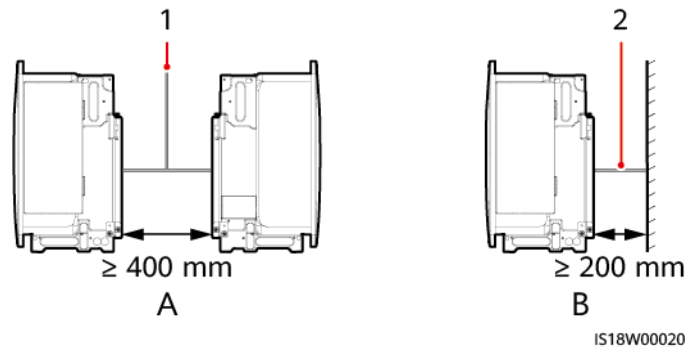

(A) Back-to-back installation mode

(B) Close-to-wall installation mode

(1) T-shaped air baffle

(2) Flat air baffle

4.4 Installing the Mounting Bracket

Step 1 Remove the torx key and store it properly.

Figure 4-6 Removing a torx key

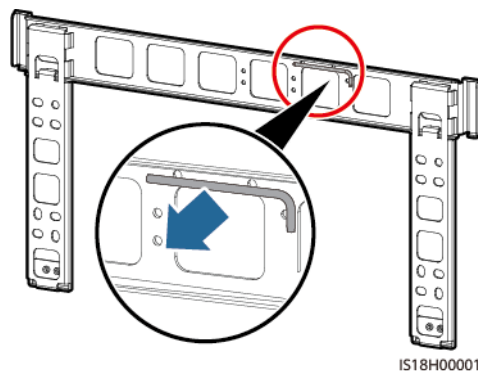

Step 2 Secure the mounting bracket.

NOTE

- The mounting bracket of the SUN2000 has four groups of tapped holes, each group containing four tapped holes. Mark any hole in each group based on site requirements and mark four holes in total. The two round holes are recommended.
- M12x40 bolt assemblies are delivered with the SUN2000 and bound to the mounting bracket. If the bolt length does not meet the installation requirements, prepare M12 bolt assemblies by yourself and use them together with the delivered M12 nuts.

Figure 4-7 Installing a mounting bracket

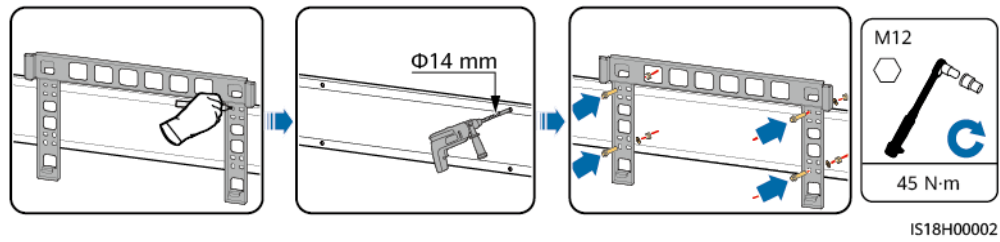

----End

4.5 Installing the SUN2000

Step 1 Take the SUN2000 out of the packing case and move it to the installation position.

NOTICE

- Handles are packed in a fitting bag and are not delivered with the SUN2000.
- Four persons or appropriate transportation tools are required to move the SUN2000.
- Do not use the ports and wiring terminals at the bottom to support any weight of the SUN2000.
- When you need to temporarily place the SUN2000 on the ground, use foam, paper, or other protection material to prevent damage to its enclosure.

Figure 4-8 Moving a SUN2000

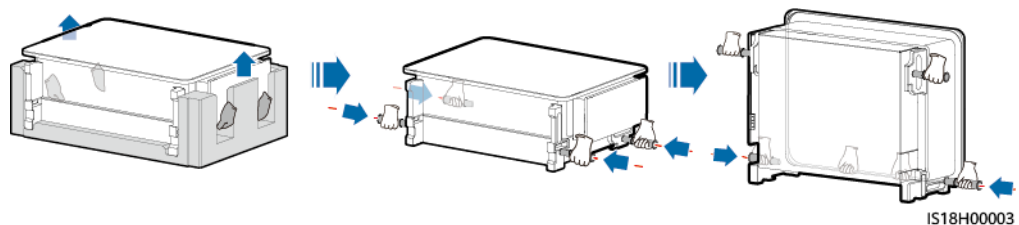

Step 2 Secure the SUN2000.

Figure 4-9 Securing a SUN2000

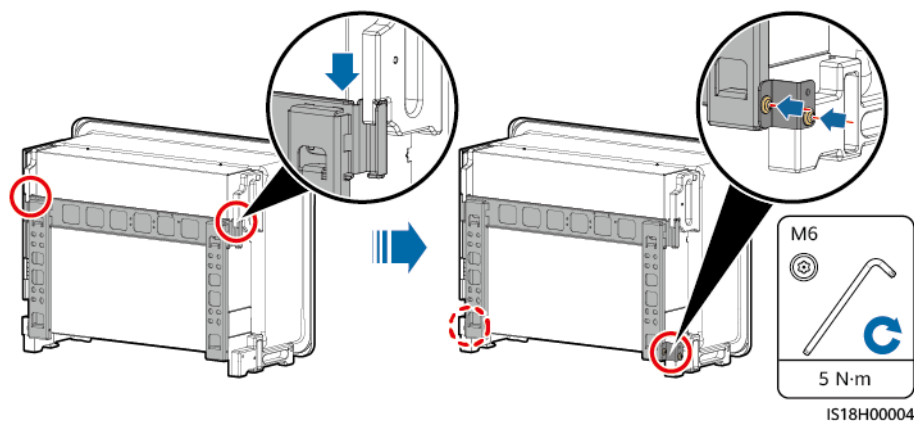

 NOTE

If the installation position is high, you can hoist the SUN2000.

Figure 4-10 Hoisting

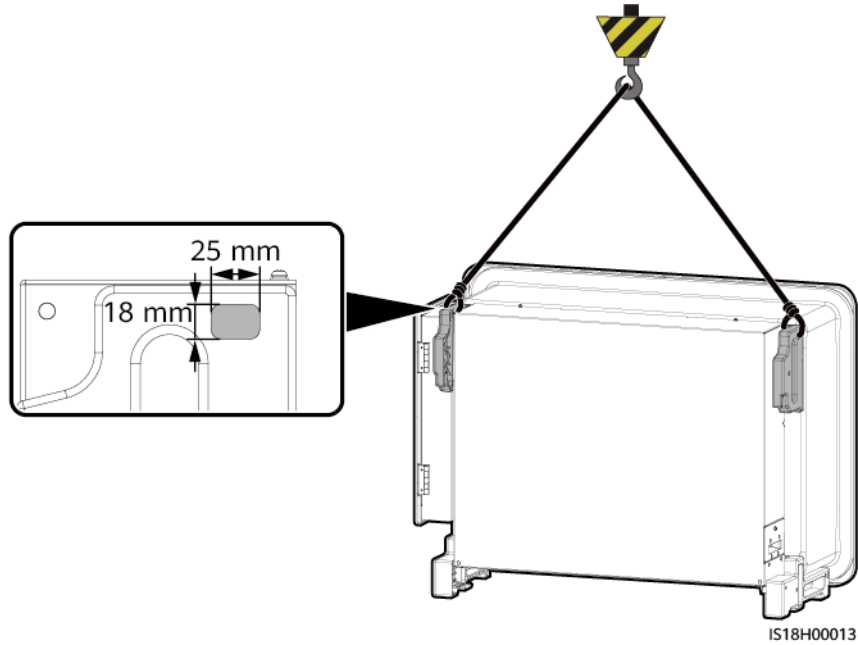

----End

5 Installing Cables

5.1 Precautions

DANGER

After the PV array receives solar irradiance, it transmits the DC voltage to the SUN2000. Before connecting cables, ensure that **MAIN SWITCH** and all **DC SWITCH** of the SUN2000 are **OFF**. Otherwise, the high voltage of the SUN2000 may result in electric shocks.





WARNING

- Device damage caused by incorrect cable connections is not covered under warranty.
- Only certified electricians are allowed to connect cables.
- Wear proper PPE at all time when connecting cables.
- Before connecting cables to ports, leave enough slack to reduce the tension on the cables and prevent poor cable connections.

NOTE

The cable colors shown in the electrical connection diagrams provided in this section are for reference only. Select cables in accordance with local cable specifications (green-and-yellow cables are only used for protective earthing).

5.2 Preparing Cables

The SUN2000 supports RS485 communication and MBUS communication. In the networking diagram,  indicates the power cable,  indicates the power flow direction, and  and  indicate the signal flow.

NOTICE

The MBUS communication is applicable to medium-voltage grid connection scenarios and non-low-voltage public grid connection scenarios (industrial environment).

Figure 5-1 MBUS networking application

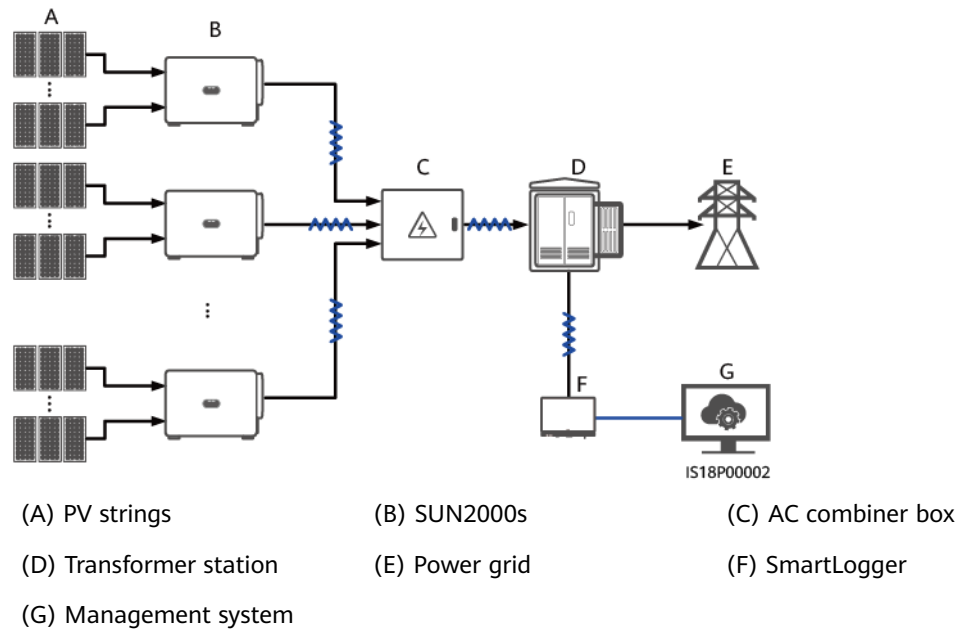
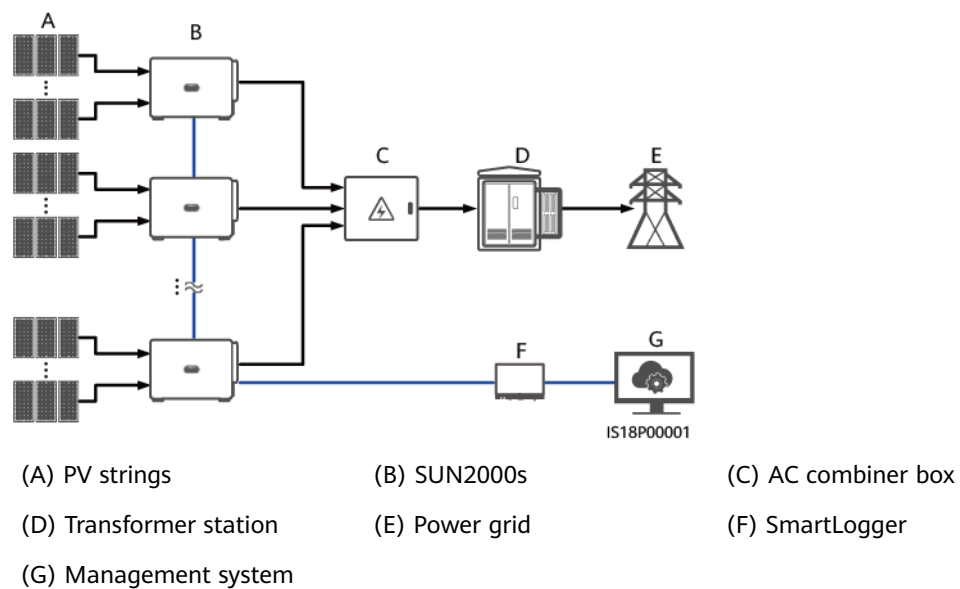

Figure 5-2 RS485 networking application



NOTICE

- To ensure the system response speed, you are advised to connect less than 30 cascading SUN2000s on each COM port of the SmartLogger.
- If RS485 communication is used, the RS485 communication distance between the SUN2000 at the end and the SmartLogger cannot exceed 1000 m.
- If MBUS communication is used, multi-core cables are recommended and the maximum communication distance is 1000 m. If single-core cables are used, the three-phase cables must be bound at an interval of 1 m

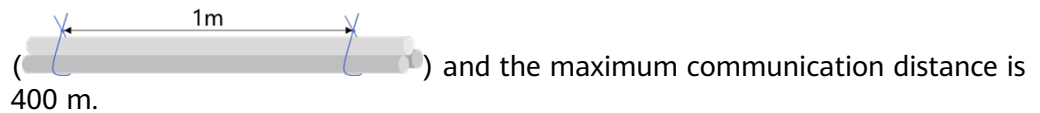
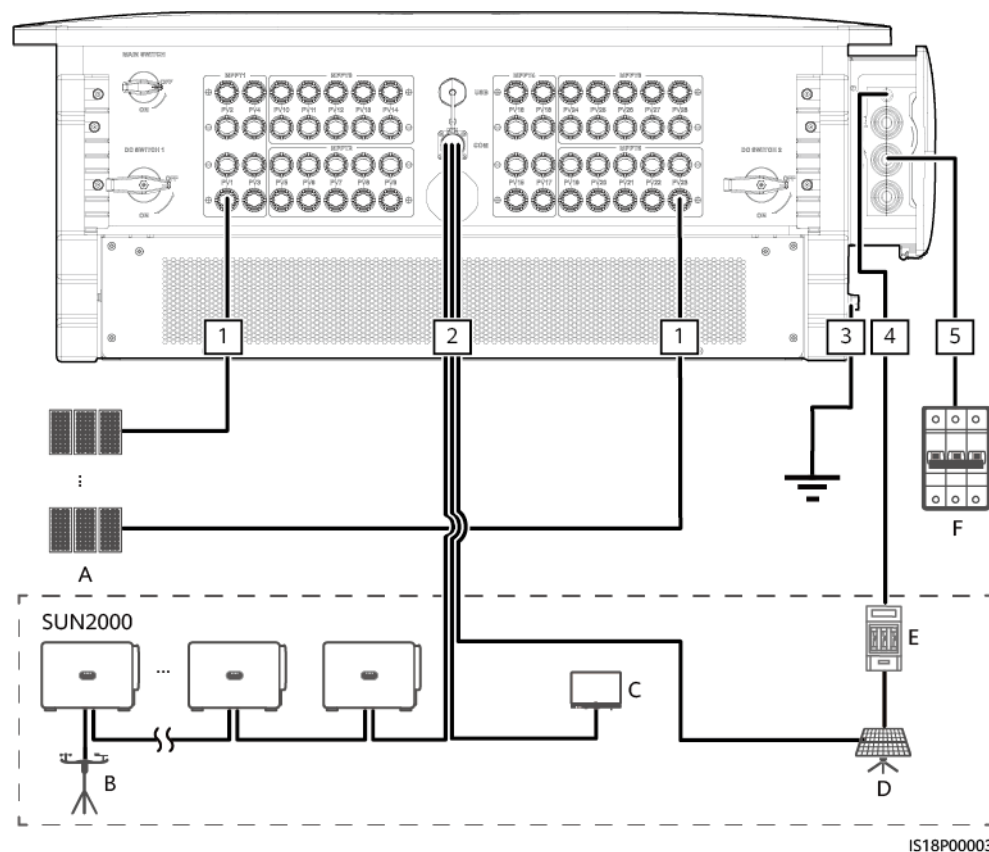

Figure 5-3 Cable connections (configure the components in the dotted box as required)



IS18P00003

Table 5-1 Component description

| No. | Component | Description | Source |
|-----|-----------|--|--------------------------|
| A | PV string | <ul style="list-style-type: none"> • A PV string consists of PV modules connected in series. • The SUN2000 supports 28 PV string inputs. | Prepared by the customer |

| No. | Component | Description | Source |
|-----|---|---|----------------------------|
| B | Environmental monitoring instrument (EMI) | When the SmartLogger is used, the EMI can be directly connected to the SmartLogger or connected to the last SUN2000 cascaded over RS485. | Prepared by the customer |
| C | SmartLogger | The SUN2000 communicates with the management system through the SmartLogger. | Purchased from the Company |
| D | Tracking system | The angle of trackers can be adjusted. | Prepared by the customer |
| E | Fuse/Circuit breaker | <p>The tracking system should be equipped with an overcurrent protection device or component. The power cable between the device or component and the wiring terminal should be shorter than or equal to 2.5 m.</p> <p>A fuse or a circuit breaker is recommended.</p> <ul style="list-style-type: none"> Installed between the SUN2000 and tracking control box Fuse specifications: rated voltage ≥ 800 V; rated current: 16 A; protection: gG Circuit breaker specifications: rated voltage ≥ 800 V; rated current: 16 A; tripping: C | Prepared by the customer |
| F | AC switch | <p>To ensure that the SUN2000 can be safely disconnected from the power grid when an exception occurs, connect an AC switch to the AC side of the SUN2000. Select an appropriate AC switch in accordance with local industry standards and regulations.</p> <ul style="list-style-type: none"> Installed in the AC combiner box Recommended: a three-phase AC circuit breaker with a rated voltage greater than or equal to 800 V AC and a rated current of 400 A | Prepared by the customer |

NOTICE

The SUN2000 has an internal residual current monitoring unit (RCMU). Its external AC switch should be a three-phase circuit breaker or any other AC load circuit breaker to safely disconnect the SUN2000 from the power grid.

NOTE

- The cable diameter must comply with local cable standards.
- The factors that affect cable selection include the rated current, cable type, routing mode, ambient temperature, and maximum expected line loss.

Table 5-2 Cable description (S indicates the conductor cross-sectional area of the AC output cable, and S_p indicates the conductor cross-sectional area of the PE cable)

| No. | Cable | Type | Conductor Cross-Sectional Area | Outer Diameter | Source |
|-----|-------------------------------------|--|--|--|--------------------------|
| 1 | DC input power cable | PV cable that meets the 1500 V standard | 4–6 mm ² | 5–7.8 mm | Prepared by the customer |
| 2 | RS485 communications cable | Outdoor shielded twisted pair cable that meets the local standard | 0.25–1 mm ² | <ul style="list-style-type: none"> • One or two communications cables: 4–11 mm • Three communications cables: 4–8 mm | Prepared by the customer |
| 3 | PE cable | Single-core outdoor copper cable and M10 OT/DT terminal | $S_p \geq S/2$ | - | Prepared by the customer |
| 4 | Tracking system power cable | Three-core outdoor copper cable with two layers of protection and M4 OT terminal | 10 mm ² | 15–18 mm | Prepared by the customer |
| 5 | AC output power cable (single-core) | (Recommended) Single-core outdoor cable and M12 OT/DT terminal | <ul style="list-style-type: none"> • Copper cable: <ul style="list-style-type: none"> - S: 150–400 mm² • Aluminum alloy cable or copper-clad aluminum cable: <ul style="list-style-type: none"> - S: 150–400 mm² | 14–40 mm | Prepared by the customer |

| No. | Cable | Type | Conductor Cross-Sectional Area | Outer Diameter | Source |
|--|------------------------------------|---|--|----------------|--------------------------|
| | AC output power cable (multi-core) | <ul style="list-style-type: none"> If the ground point on the enclosure is used, three-core (L1, L2, and L3) outdoor cables and M12 OT/DT terminals (L1, L2, and L3) are recommended. If the ground point in the maintenance compartment is used, four-core (L1, L2, L3, and PE) outdoor cables, M12 OT/DT terminals (L1, L2, and L3), and M10 OT/DT terminals (PE) are recommended. You do not need to prepare a PE cable. | <ul style="list-style-type: none"> Copper cable: <ul style="list-style-type: none"> S: 150–240 mm² $S_p \geq S/2$ Aluminum alloy cable or copper-clad aluminum cable: <ul style="list-style-type: none"> S: 150–400 mm² $S_p \geq S/2$ | 24–66 mm | Prepared by the customer |
| <p>The value of S_p is valid only if the conductors of the PE cable and AC power cable use the same material. If the materials are different, ensure that the conductor cross-sectional area of the PE cable produces a conductance equivalent to that specified in this table. The specifications of the PE cable are subject to this table or calculated according to IEC 60364-5-54.</p> | | | | | |

5.3 Crimping an OT or DT Terminal

Requirements for OT/DT Terminals

- If a copper cable is used, use copper wiring terminals.
- If a copper-clad aluminum cable is used, use copper wiring terminals.
- If an aluminum alloy cable is used, use copper-to-aluminum wiring terminals, or aluminum wiring terminals with copper-to-aluminum washers.

NOTICE

- Do not connect aluminum wiring terminals to the terminal block. Otherwise electrochemical corrosion may occur, affecting the reliability of cable connections.
- Comply with the IEC 61238-1 requirements when using copper-to-aluminum wiring terminals, or aluminum wiring terminals with copper-to-aluminum washers.
- Ensure that the aluminum side of the washer contacts the aluminum wiring terminal, and the copper side contacts the terminal block.

Figure 5-4 Requirements for OT/DT terminals

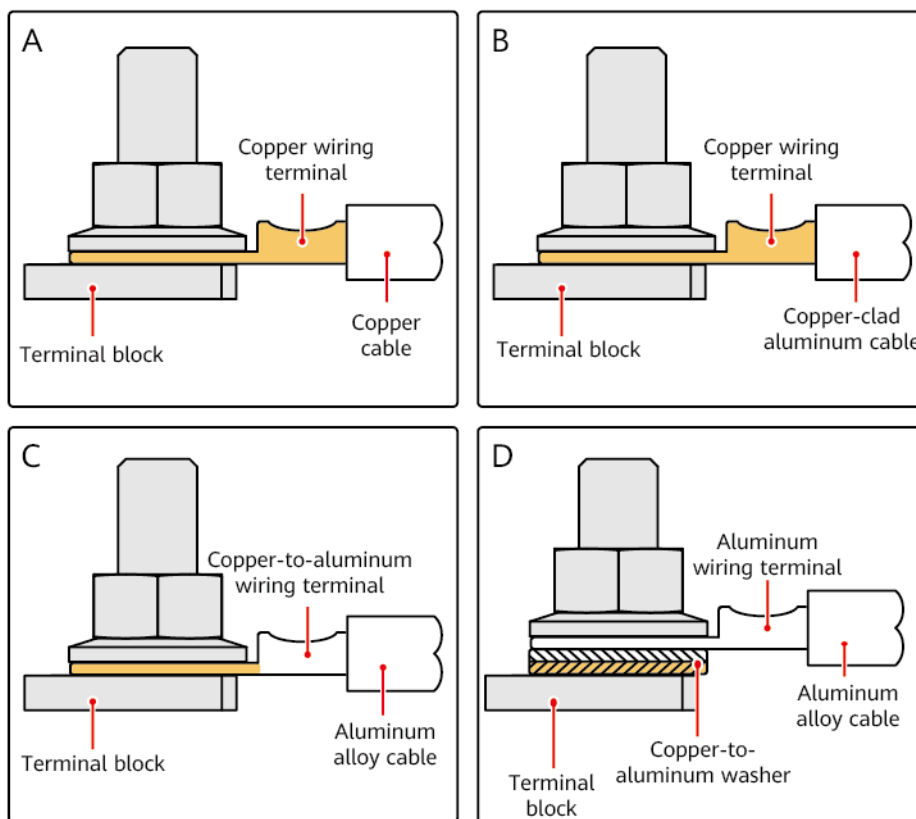

Crimping an OT or DT Terminal

NOTICE

- Avoid damaging the core wire when stripping a cable.
- The cavity formed after the conductor crimp strip of the OT or DT terminal has been crimped must wrap around the core wires completely. The core wires must be in close contact with the OT or DT terminal closely.
- Wrap the wire crimping area with heat-shrink tubing or insulation tape. The heat-shrink tubing is used in this section as an example.
- Use a heat gun carefully to avoid heat damage to the equipment.

Figure 5-5 Crimping an OT terminal

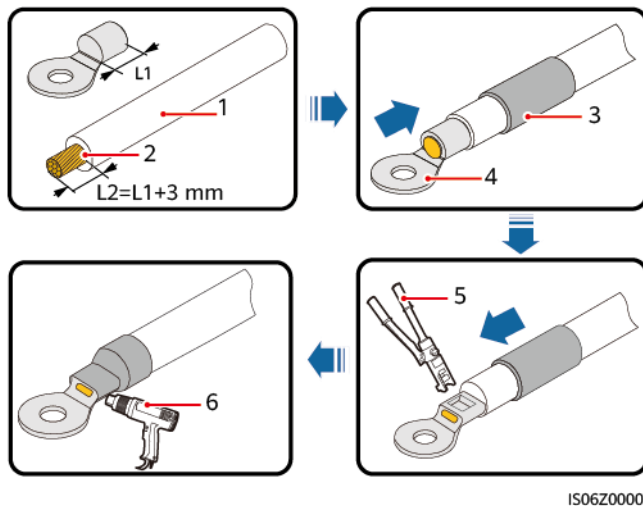

IS06Z00001

(1) Cable

(2) Core

(3) Heat-shrink tubing

(4) OT terminal

(5) Hydraulic pliers

(6) Heat gun

Figure 5-6 Crimping a DT terminal

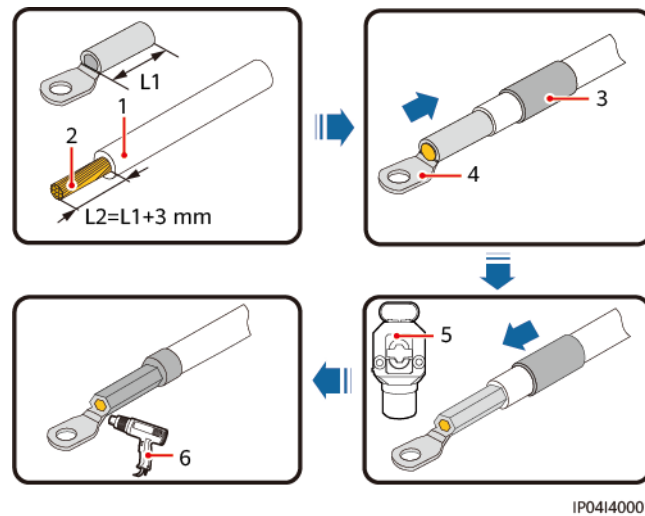

- | | | |
|-----------------|----------------------|------------------------|
| (1) Cable | (2) Core | (3) Heat-shrink tubing |
| (4) DT terminal | (5) Hydraulic pliers | (6) Heat gun |

5.4 Installing PE Cables and AC Power Cables

Precautions

- The ground point on the enclosure is preferred to connect to the PE cable for the SUN2000. The ground point in the maintenance compartment is used for connecting to the PE wire of a multi-core AC power cable.
- It is recommended that the SUN2000 be connected to a nearby ground point. For a system with multiple SUN2000s connected in parallel, connect the ground points of all SUN2000s to ensure equipotential connections to PE cables.
- A three-phase AC switch should be installed on the AC side of the SUN2000. To ensure that the SUN2000 can safely disconnect itself from the power grid when an exception occurs, select a proper overcurrent protection device in compliance with local power distribution regulations.
- The SUN2000 is integrated with a comprehensive residual current detection unit to distinguish fault current from residual current. Upon detecting that the residual current exceeds the threshold, the SUN2000 immediately disconnects from the power grid.

WARNING

- Do not connect loads between the SUN2000 and the AC switch. Otherwise, the switch may trip by mistake.
- If an AC switch is used with specifications beyond local standards, regulations, or Huawei's recommendations, the switch may fail to turn off in a timely manner in case of exceptions, causing serious faults.
- Do not open the panel of the SUN2000.
- Before opening the maintenance compartment door, ensure that no electrical connections are made for the SUN2000 on the AC or DC side.
- Do not open the maintenance compartment door on rainy or snowy days. If you need to, take protective measures to prevent rain or snow from entering the maintenance compartment. If protective measures cannot be taken, do not open the maintenance compartment door.
- Do not leave unused screws in the maintenance compartment.

CAUTION

- Each SUN2000 must be equipped with a three-phase AC switch. Multiple SUN2000s cannot connect to the same AC switch.

NOTICE

- The cable outer diameter can be measured using the ruler sticker in the maintenance compartment.
- Ensure that the cable jacket is in the maintenance compartment.
- Ensure that the AC output power cables are connected securely. Otherwise, the SUN2000 may fail to operate, or become overheated during operation due to an unreliable connection, which will damage the terminal block.

Table 5-3 Bending radius requirements for AC power cables

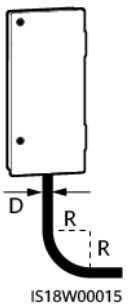
| Picture | Single-core Cable | | Three-core or Four-core Cable | |
|---|---|--------------|-------------------------------|--------------|
| | Unarmored | Armored | Unarmored | Armored |
|  | $R \geq 20D$ | $R \geq 15D$ | $R \geq 15D$ | $R \geq 12D$ |
| | <p>R indicates the bending radius, and D indicates the outer diameter of the cable.</p> <p>NOTE The AC power cable must be routed vertically into the maintenance compartment.</p> | | | |

Procedure

- Step 1** Connect the PE cable to the ground point. To enhance the corrosion resistance of a ground terminal, apply silicone grease or paint on it after connecting the PE cable.

Figure 5-7 Connecting a PE cable to the ground point (on the enclosure)

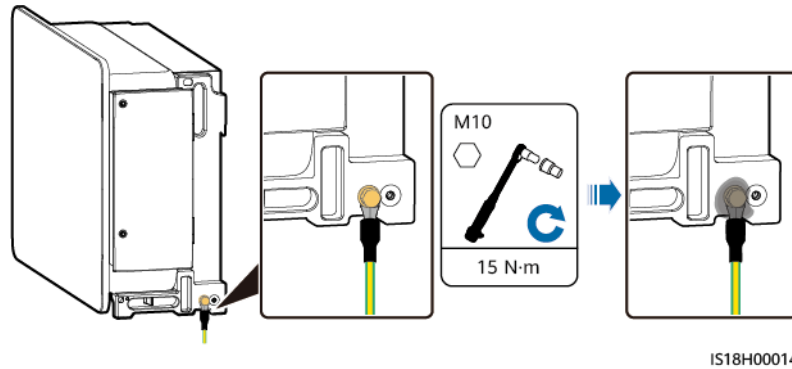

- Step 2** Open the maintenance compartment door and install the support strut. Remove the accessories and set them aside.

Figure 5-8 Opening a maintenance compartment door

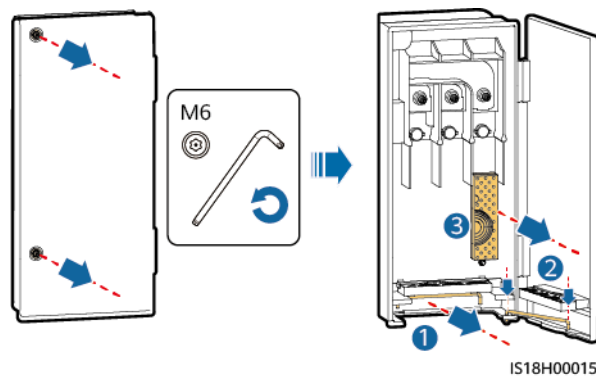

- Step 3** Connect the AC output power cables based on the cable type.

Figure 5-9 Cable connection

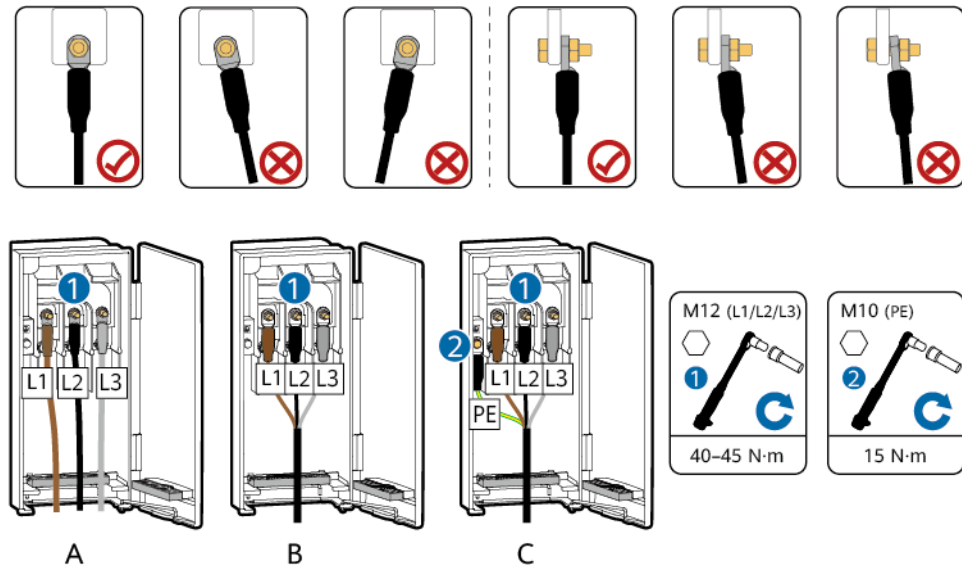

(A) Single-core cables

(B) Three-core cable

(C) Four-core cable

NOTICE

Reserve sufficient slack for the PE cable to ensure that the last cable bearing the force is the PE cable when the AC output power cable is subject to a pulling force due to force majeure.

Figure 5-10 Single-core cable connection

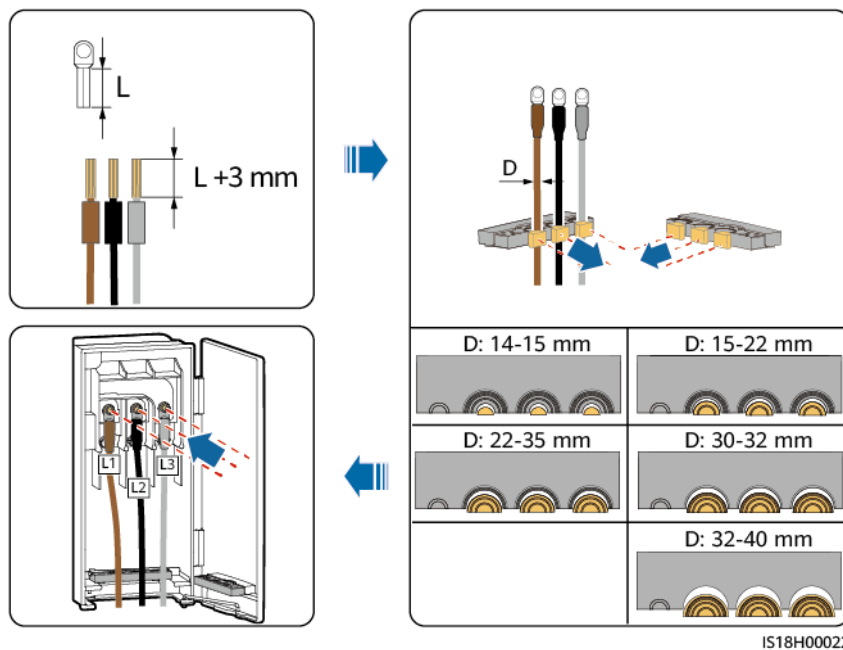
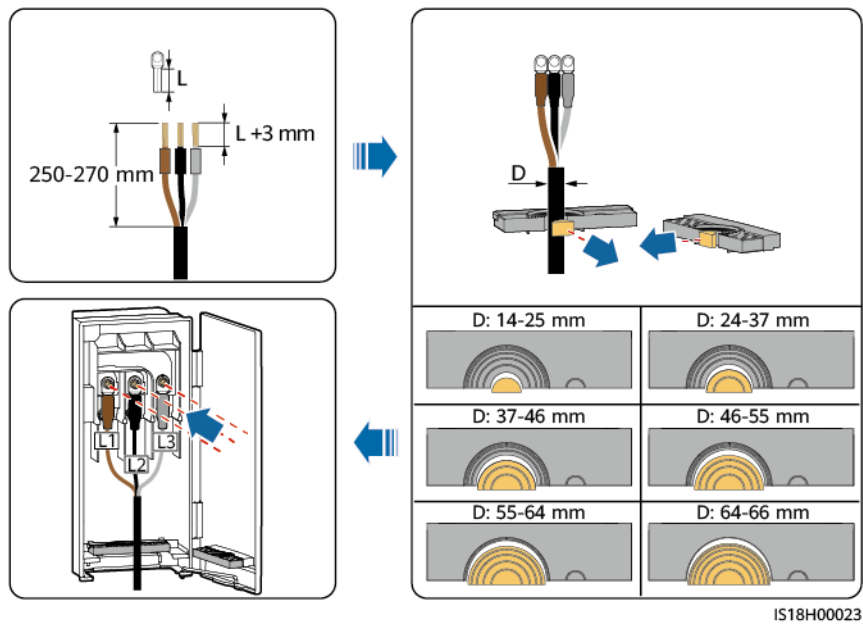

Figure 5-11 Multi-core cable connection (using a three-core cable as an example)



Step 4 If the system is configured with a tracking system, connect the power cable of the tracking system.

⚠ WARNING

- The tracking system obtains power from the AC three-phase power grid. The rated voltage of the power supply is the rated output voltage of the SUN2000.
- Keep flammable materials away from cables.
- Cables must be protected with a conduit to prevent short circuits caused by insulation layer damage.

Figure 5-12 Connecting a power cable of the tracking system

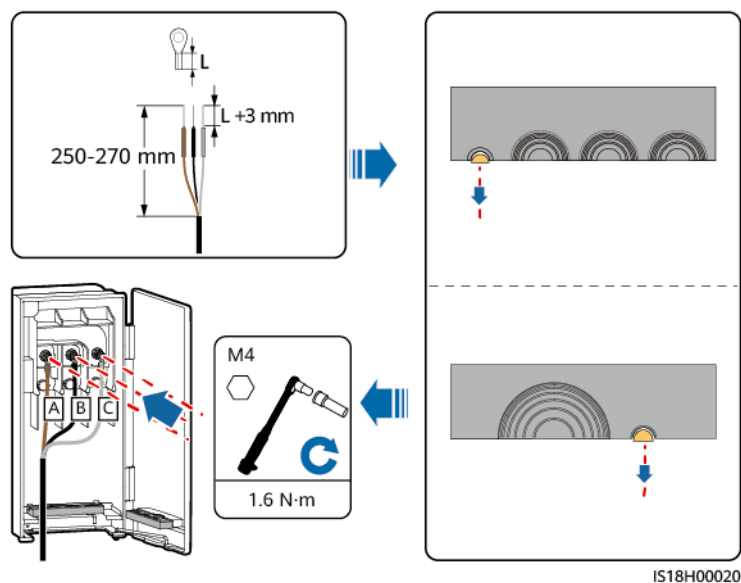

- Step 5** Clear foreign matter from the maintenance compartment, close the maintenance compartment door, and check that the cable holes at the bottom of the maintenance compartment are sealed.

Figure 5-13 Closing a door

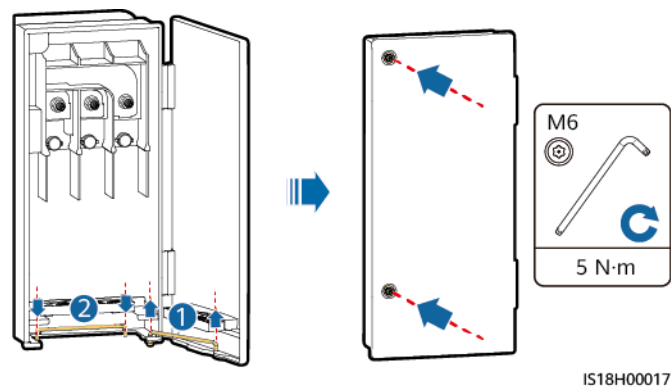

----End

5.5 Installing DC Power Cables

Precautions

⚠ DANGER

- Before connecting DC input power cables, ensure that the DC voltage is within the safe range (lower than 60 V DC) and that **MAIN SWITCH** and all **DC SWITCH** of the SUN2000 are **OFF**. Otherwise, the high voltage may result in electric shocks.
- When the SUN2000 operates in grid-tied mode, do not perform maintenance or operations on the DC input power cables, such as connecting or disconnecting a PV string or a PV module in the PV string. Otherwise, electric shocks or arcing (which may cause fire) may occur.

⚠ WARNING

Ensure that the following conditions are met. Otherwise, the SUN2000 may be damaged or even a fire may occur.

- The open-circuit voltage of each PV string must be lower than or equal to 1500 V DC under any circumstances.
 - The polarities of electric connections are correct on the DC input side. The positive and negative terminals of a PV string connect to corresponding positive and negative DC input terminals of the SUN2000.
-

NOTICE

- Ensure that the PV module output is well insulated to ground.
- The PV strings connecting to the same MPPT circuit should use the same model and quantity of PV modules.
- The SUN2000 does not support full parallel connection for PV strings (full parallel connection: PV strings connect to one another in parallel and then connect to the SUN2000 separately).
- The SUN2000 does not support Y-branch PV connectors.
- During the installation of PV strings and the SUN2000, the positive or negative terminals of PV strings may be short-circuited to ground if the power cables are not properly installed or routed. In this case, an AC or DC short circuit may occur and damage the SUN2000. The resulting device damage is not covered under any warranty.

Terminal Description

The SUN2000 provides 28 DC input terminals, which are controlled by its two DC switches. DC SWITCH 1 controls the DC input terminals PV1–14 and DC SWITCH 2 controls the DC input terminals PV15–28.

Figure 5-14 DC terminals controlled by DC SWITCH 1

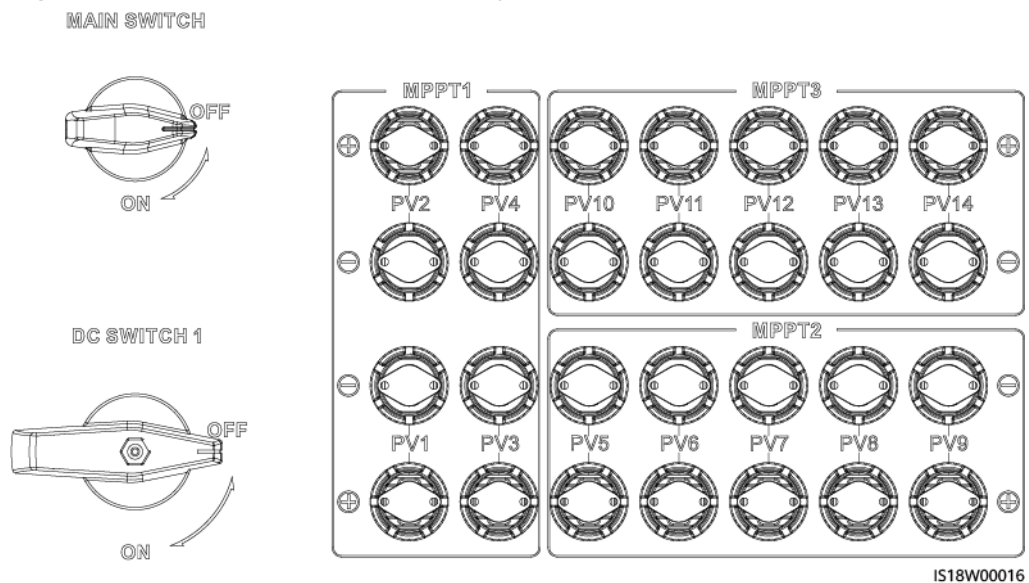
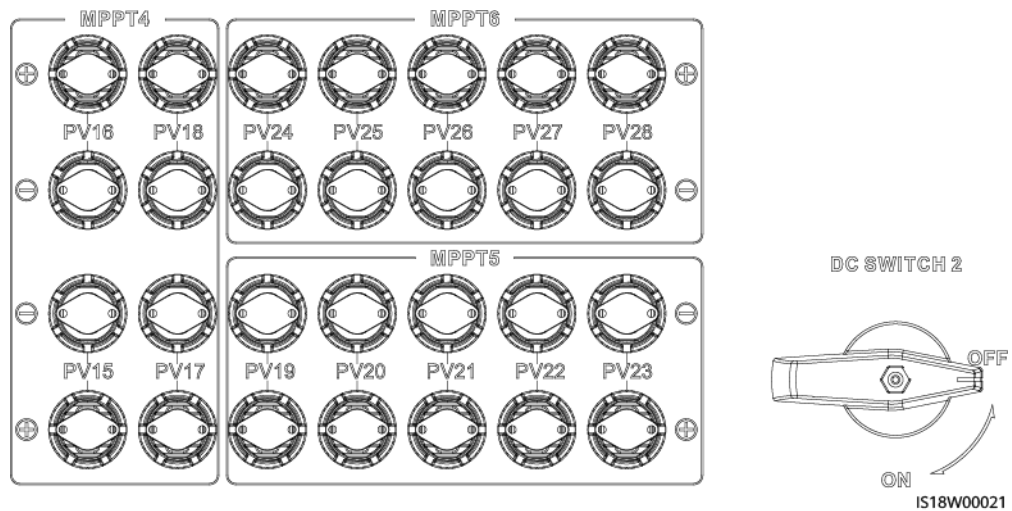

Figure 5-15 DC terminals controlled by DC SWITCH 2



Requirements for selecting DC input terminals:

1. DC input terminal PV10 must be connected to a PV string.
2. At least one PV string is connected to the DC input terminals PV1–PV9.
3. You are advised to connect PV strings to DC input terminals PV1, PV2, PV3, PV5, PV6, PV7, PV10, P11, PV12, PV15, PV16, PV17, PV19, PV20, PV21, PV24, P25, and PV26 preferentially.

For example, if there are 18 to 27 PV strings, you are advised to connect DC input terminals as follows:

| Number of PV Strings | Terminal Selection | Number of PV Strings | Terminal Selection |
|----------------------|--|----------------------|---|
| 18 | Connect to PV1–PV3, PV5–PV7, PV10–PV12, PV15–PV17, PV19–PV21, and PV24–PV26. | 19 | Connect to PV1–PV7, PV10–PV12, PV15–PV17, PV19–PV21, and PV24–PV26. |
| 20 | Connect to PV1–PV7, PV10–PV12, PV15–PV17, PV19–PV21, and PV24–PV27. | 21 | Connect to PV1–PV8, PV10–PV12, PV15–PV17, PV19–PV21, and PV24–PV27. |
| 22 | Connect to PV1–PV8, PV10–PV12, PV15–PV17, PV19–PV22, and PV24–PV27. | 23 | Connect to PV1–PV8, PV10–PV13, PV15–PV17, PV19–PV22, and PV24–PV27. |
| 24 | Connect to PV1–PV13, PV15–PV17, PV19–PV22, and PV24–PV27. | 25 | Connect to PV1–PV17, PV19–PV22, and PV24–PV27. |
| 26 | Connect to PV1–PV17, PV19–PV22, and PV24–PV28. | 27 | Connect to PV1–PV22 and PV24–PV28. |

Procedure

NOTICE

- Use the HH4SFD4TMS/HH4SMD4TMS PV connectors delivered with the SUN2000. If the PV connectors are lost or damaged, purchase the connectors of the same model. The device damage caused by incompatible PV connectors is not covered under any warranty.
- The DC voltage measurement range of the multimeter must be at least 1500 V.
- If the voltage is a negative value, the DC input polarity is incorrect. Rectify the connection.
- If the voltage is greater than 1500 V, too many PV modules are connected to the same string. Remove some PV modules.
- Connect the connectors on the PV strings to the connectors on the inverter, and pull back the connectors on the PV strings along the axial direction to check whether the connectors are securely installed.
- Ensure that the connectors are properly connected. If any connector damage due to improper connection is not covered by the warranty.

Step 1 Connect DC input power cables.

Figure 5-16 Connecting DC input power cables

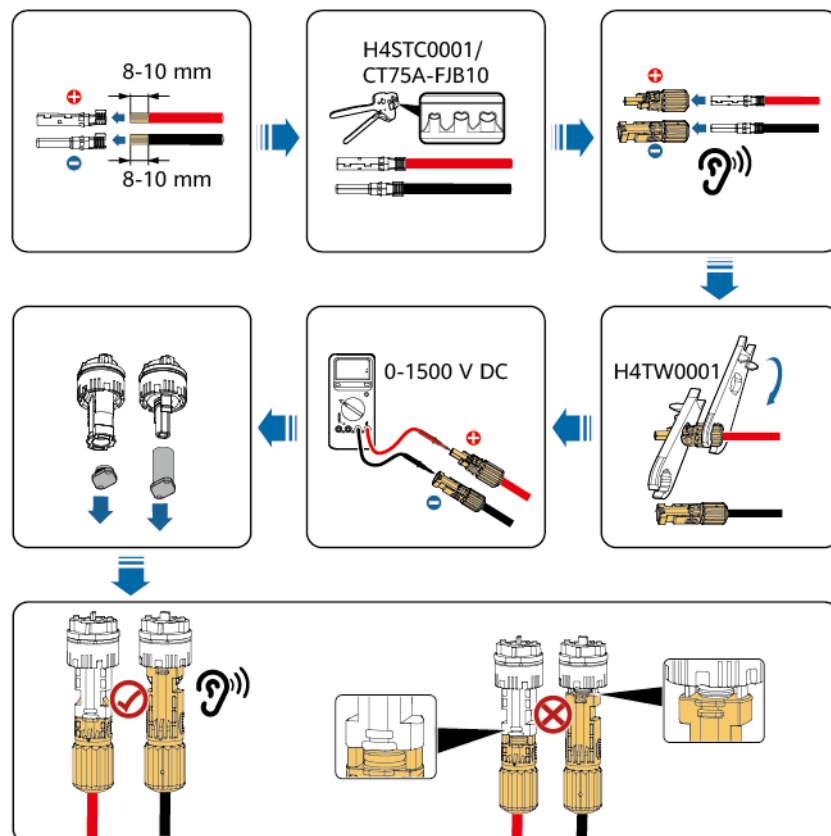

IS18H00019

NOTICE

During DC input power cabling, leave at least 50 mm of slack. The axial tension on PV connectors must not exceed 80 N. Radial stress or torque must not be generated on PV connectors.

----End

5.6 Installing Communications Cables

Precautions

When routing communications cables, separate communications cables from power cables to prevent communication from being affected.

COM Port Pin Definitions

Figure 5-17 Communications port

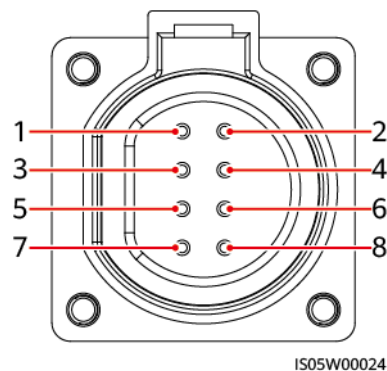

| Port | Pin | Definition | Pin | Definition | Description |
|---------|-----|---------------------------------------|-----|--|--|
| RS485-1 | 1 | RS485A IN, RS485 differential signal+ | 2 | RS485A OUT, RS485 differential signal+ | Used to cascade SUN2000s or connect devices such as the SmartLogger. |
| | 3 | RS485B IN, RS485 differential signal- | 4 | RS485B OUT, RS485 differential signal- | |
| PE | 5 | PE, shield layer grounding | 6 | PE, shield layer grounding | - |
| RS485-2 | 7 | RS485A, RS485 differential signal+ | 8 | RS485B, RS485 differential signal- | Used to connect an RS485 slave device. |

Procedure

Step 1 Connect the RS485 communications cables.

Figure 5-18 Connecting communications cables

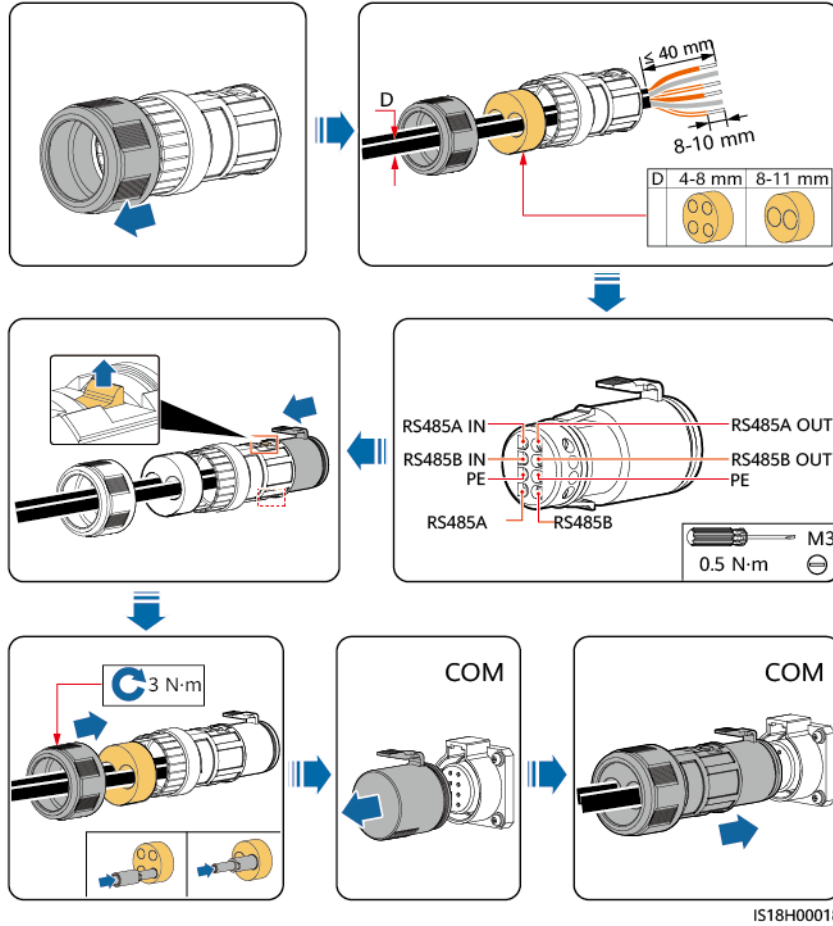

NOTICE

Use a plug to block the unused cable hole with the waterproof rubber ring, and then tighten the locking cap.

----End

6 Power-On Commissioning

6.1 Check Before Power-On

| No. | Check Item | Acceptance Criteria |
|-----|-------------------------|---|
| 1 | Overall installation | <ul style="list-style-type: none">• The SUN2000 is installed correctly and securely.• The installation space is proper, and the installation environment is clean and tidy. |
| 2 | Appearance | <ul style="list-style-type: none">• The SUN2000 exterior is intact without deviation, deformation, peeling paint, or rust.• Cables are intact and routed neatly. |
| 3 | Switch | MAIN SWITCH, DC SWITCH , and downstream AC output switch are OFF . |
| 4 | PE cable | The PE cable is connected correctly, securely, and reliably. |
| 5 | AC power cable | AC power cables are connected correctly and securely. |
| 6 | Maintenance compartment | <ul style="list-style-type: none">• The maintenance compartment interior is clean and tidy without foreign matter• After the check, ensure that the maintenance compartment door is closed and the screws on the door are tightened. |
| 7 | DC power cable | DC power cables are connected correctly and securely. |
| 8 | Unused port | <ul style="list-style-type: none">• Unused DC terminals are sealed with sealing plugs.• Unused COM and USB ports are plugged with waterproof plugs. |

6.2 System Power-On

WARNING

When the grid connection indicator is steady green (the SUN2000 is connected to the power grid), do not turn on the DC switch. Otherwise, the SUN2000 may be damaged because insulation resistance detection is not performed.

NOTICE

- Before turning on the AC switch between the SUN2000 and the power grid, check that the AC voltage is within the specified range using a multimeter.
 - If a SUN2000 has not been running for more than half a year after being mounted, it must be checked and tested by professionals before being put into operation.
 - When the system is powered on for the first time, ensure that **MAIN SWITCH** is turned on first. After the PV connection indicator is steady on, turn on **DC SWITCH 1** and **DC SWITCH 2**. After the system is successfully connected to the power grid, turn off **MAIN SWITCH**. The Company is not liable for any device damage caused by operations not performed in this sequence.
 - The DC switches implement automatic disconnection. If cables are reversely connected or PV modules are not properly configured, the DC switches automatically turn off for protection. In this case, clear the alarm on the app and turn on the DC switches only after confirming that the alarm is cleared. Device damage caused by forcible switch-on after the DC switches turn off is not covered by the warranty.
 - When the system is powered on or running, ensure that there are no obstacles (for example, cables or operators' misoperations) that stop the rotation of the DC switch handles. Otherwise, the DC switches cannot automatically turn off.
 - If you perform [Step 3](#) before [Step 2](#), the SUN2000 reports a fault about abnormal shutdown. You can start the SUN2000 only after the fault is automatically rectified.
-

Step 1 Wear proper personal protective equipment (PPE).

Step 2 Turn on the AC switch between the SUN2000 and the power grid.

Step 3 Set **MAIN SWITCH** at the bottom of the SUN2000 to **ON**. When you hear a click, the switch is completely turned on. Observe the LED indicators.

Step 4 If the PV connection indicator is steady green, set **DC SWITCH 1** and **DC SWITCH 2** to **ON**. Observe the LED indicators to check the operating status of the SUN2000.

If the PV connection indicator is off 1 minute after the SUN2000 is powered on, do not turn on the **DC SWITCH**. At the same time, turn off **MAIN SWITCH** immediately and check whether the input power cables are reversely connected or

whether the input voltage meets the startup voltage requirements. After the fault is rectified, run the **Step 3** command again. If the PV connection indicator is off, disconnect **MAIN SWITCH** and contact technical support engineers.

Step 5 If the SUN2000 does not report an alarm, turn off **MAIN SWITCH**.

NOTICE

MAIN SWITCH needs to be turned on only when the system is powered on for the first time and needs to be turned off during subsequent operation.

Step 6 Set the parameters over the app or SmartLogger. For details, see **7.1 Operations with the App** or the SmartLogger user manual.

Figure 6-1 Power-on

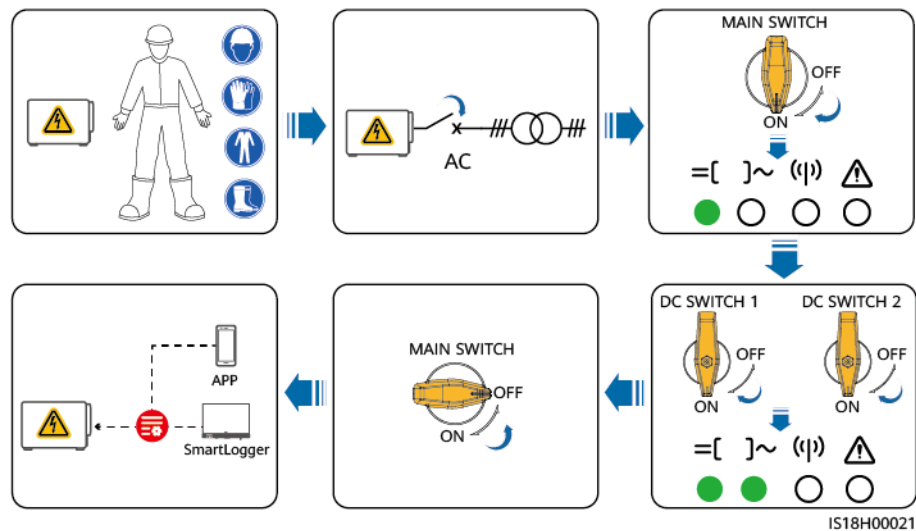

IS18H00021

----End

7 Man-Machine Interactions

7.1 Operations with the App

7.1.1 App Introduction

Functions

- If the SUN2000 is connected to the FusionSolar Smart PV Management (Cloud), the FusionSolar app is recommended. If the SUN2000 is connected to other management systems, the SUN2000 app is recommended.
- The SUN2000 app and FusionSolar app (also referred to as the app) are mobile phone applications that can communicate with the SUN2000 via a WLAN module or USB data cable to query alarms, set parameters, and perform routine maintenance. The app is a convenient local maintenance platform.

Connection Mode

After the DC or AC side of the SUN2000 is powered on, the app can connect to the SUN2000 via a WLAN module or a USB data cable.

NOTICE

- The **USB-Adapter2000-C** WLAN module is supported.
 - The USB 2.0 port is supported. Use the USB data cable delivered with the phone.
 - The mobile phone operating system must be Android 4.0 or later.
 - Huawei and Samsung phones are recommended.
-

Figure 7-1 WLAN module connection

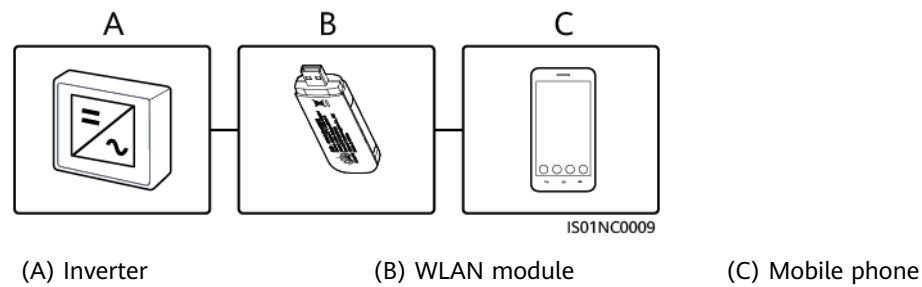
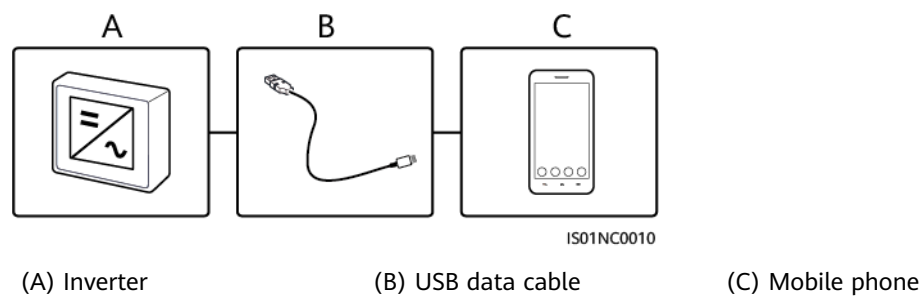

Figure 7-2 USB data cable connection



Statement

NOTICE

- The screenshots are for reference only.
- The configurable parameters of the SUN2000 vary with the device model and grid code.
- Changing the grid code may restore some parameters to factory defaults. Check whether the previously set parameters are affected.
- Sending a reset, factory reset, shutdown, or upgrade command to the SUN2000 may cause power grid connection failure, which affects the energy yield.
- Only professionals are allowed to set the grid, protection, feature, and power adjustment parameters of the SUN2000. If the grid, protection, and feature parameters are set incorrectly, the SUN2000 may disconnect from the grid. If the power adjustment parameters are set incorrectly, the SUN2000 may not connect to the power grid as required. In these cases, the energy yield will be affected.
- The parameter names, value ranges, and default values are subject to change.

7.1.2 Downloading and Installing the App

- FusionSolar app: Access Huawei AppGallery, search for **FusionSolar** (<https://appgallery.huawei.com/app/C102851109>), or scan the QR code below.
- SUN2000 app: Access Huawei AppGallery, search for **SUN2000** (<https://appgallery.huawei.com/app/C10279542>) or scan the QR code below (<https://appgallery.cloud.huawei.com/appdl/C10279542>).

Figure 7-3 QR codes

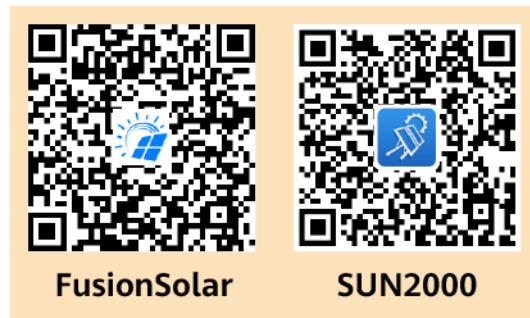

7.1.3 Logging In to the App

Prerequisites

- The DC or AC side of the SUN2000 has been energized.
- When connecting through a WLAN module:
 - a. Ensure that the WLAN module has been inserted into the **USB** port at the bottom of the SUN2000.
 - b. Ensure that the WLAN function has been enabled on your phone.
 - c. Keep the phone within 5 m from the SUN2000. Otherwise, communication between them might be affected.
- When connecting through a USB data cable:
 - a. Ensure that the USB data cable is connected from the USB port at the bottom of the SUN2000 to the USB port on the mobile phone.
 - b. Ensure that the USB data cable has been successfully connected and **Connected to USB Accessory** is displayed on the screen. Otherwise, the connection is invalid.

Procedure

1. Open the app and select a connection mode.

NOTE

- Obtain the app of the latest version from Huawei AppGallery.
 - When the WLAN connection is used, scan the QR code of the WLAN module to access the login screen.
 - When the WLAN connection is used, the initial name of the WLAN hotspot is **Adapter-WLAN module SN** and the initial password is **Changeme**. Use the initial password for the first login and change it immediately after login. To ensure account security, protect the password by changing it periodically, and keep it secure. Your password might be stolen or cracked if it is left unchanged for extended periods. If a password is lost, devices cannot be accessed. In these cases, the Company shall not be liable for any loss caused to the plant.
 - When the USB connection is used, after you select **Use by default for this USB accessory**, the message will not appear if you log in to the app again without removing the USB cable.
- a. In the scenarios where the SUN2000 is connected to the FusionSolar SmartPVMS (Cloud), open the FusionSolar app and choose **Commissioning**.

Figure 7-4 Selecting a connection mode (Internet access available)

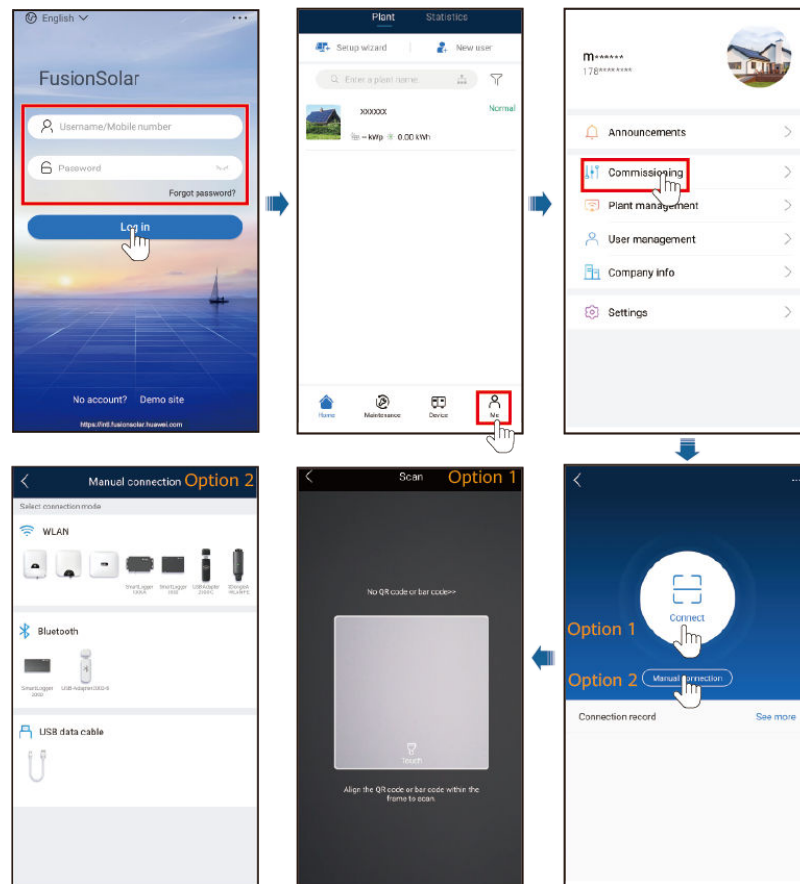
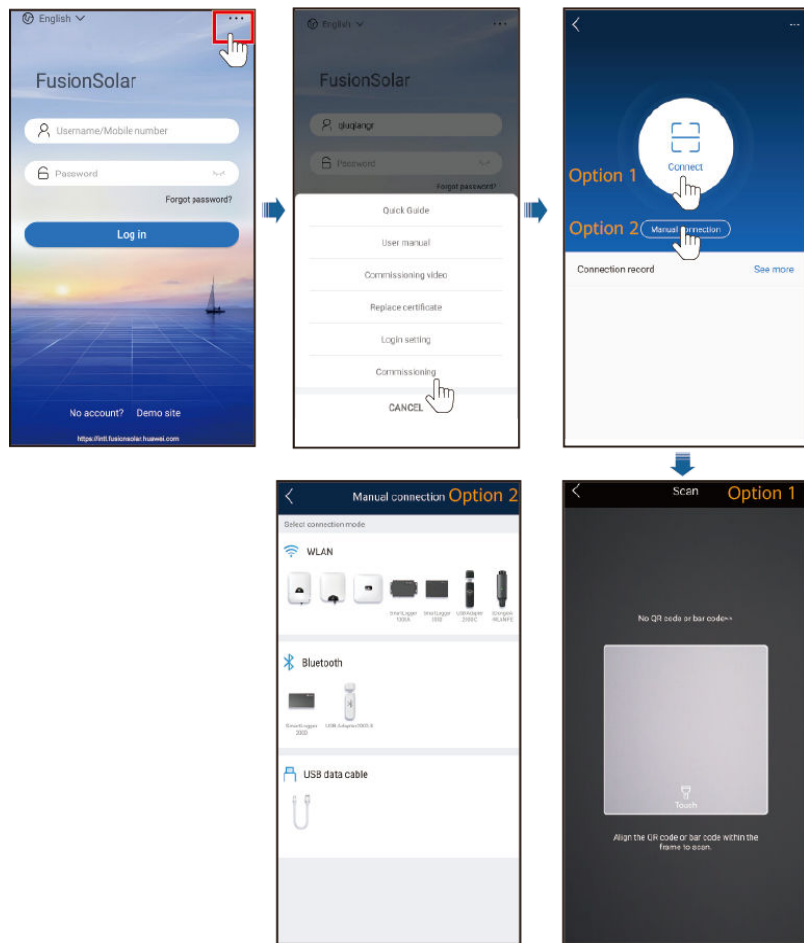
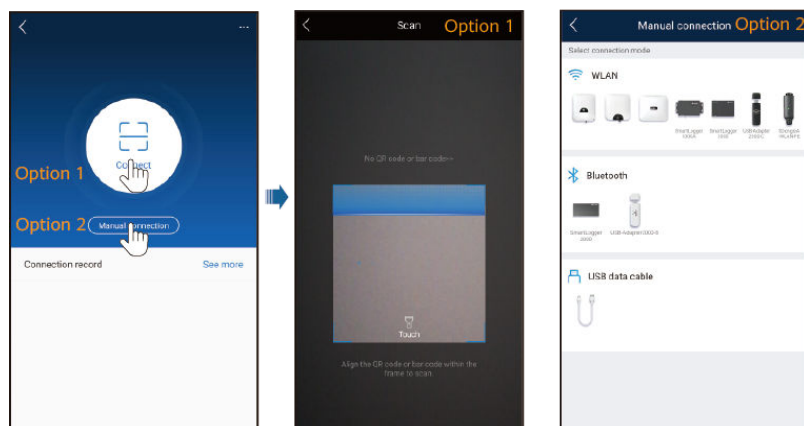

Figure 7-5 Selecting a connection mode (Internet access unavailable)



- b. In the scenarios where the SUN2000 is connected to other management systems, open the SUN2000 app and access the operation screen to select a connection mode.

Figure 7-6 Selecting a connection mode



- 2. Select a login user and enter the login password to access the quick settings screen or the main menu screen.

NOTICE

- The login password is the same as that for the SUN2000 connected to the app and is used only when the SUN2000 connects to the app.
- The initial password for **Common User**, **Advanced User**, and **Special User** is **00000a**.
- Use the initial password for the first login and change it immediately after login. To ensure account security, protect the password by changing it periodically, and keep it secure. Your password might be stolen or cracked if it is left unchanged for extended periods. If a password is lost, devices cannot be accessed. In these cases, the Company shall not be liable for any loss caused to the plant.
- You will be locked out for 10 minutes after five consecutive failed password attempts (the interval between two consecutive entries is less than 2 minutes). The password should consist of six digits.
- If you log in to the app after the device connects to the app for the first time or restores to factory settings, the quick settings screen will be displayed. Set basic parameters as prompted. If you do not set basic parameters for the SUN2000 on the quick settings screen, the screen is still displayed when you log in to the app next time.
- To set the basic parameters on the quick settings screen, switch to **Advanced User**. When you log in as **Common User** or **Special User**, enter the password of **Advanced User** in the dialog box and confirm the password to access the **Quick Settings** screen.

Figure 7-7 Login

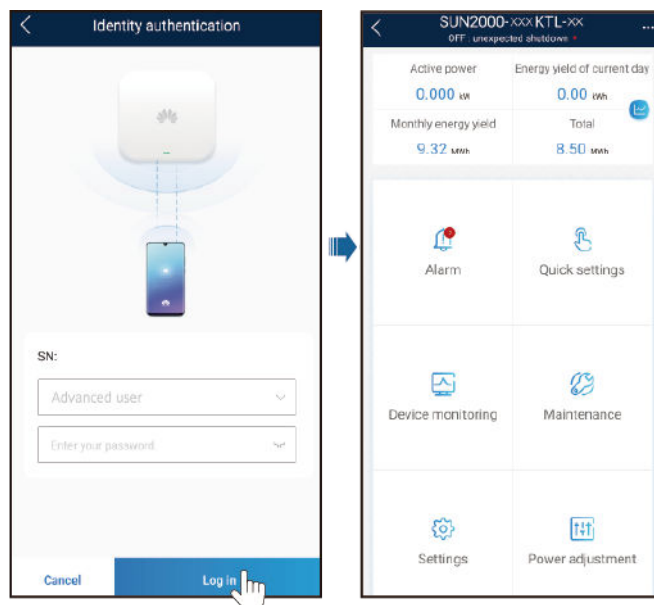

7.2 Upgrading the SUN2000 Using a USB Flash Drive

USB flash drives of SanDisk, Netac, and Kingston are recommended. Other brands may be incompatible.

 **NOTE**

Delete the script file immediately after use to reduce information disclosure risks.

Procedure

- Step 1** Download the required software upgrade package from the technical support website.
- Step 2** Decompress the upgrade package and copy all files to the root directory of the USB flash drive.

NOTICE

Do not modify the content in the upgrade package because the files involve RSA signature verification. If you modify the content, the upgrade will fail.

- Step 3** Connect the USB flash drive to the USB port. The system automatically identifies the USB flash drive and executes all commands specified in the boot script file. View the LED indicator to determine the operating status.

Table 7-1 LED indicator description

| LED Indicator | Status | Meaning |
|---|-----------------------|--|
|  | Green off | There is no operation with a USB flash drive. |
| | Blinking green slowly | There is an operation with a USB flash drive. |
| | Blinking green fast | An operation with a USB flash drive has failed. |
| | Steady green | An operation with a USB flash drive is successful. |

- Step 4** The system automatically restarts when the upgrade is completed. All LED indicators are off during the restart. After the restart, the indicator is blinking green slowly for 1 minute and then it becomes steady green, which indicates that the upgrade is successful.

----End

8 Maintenance

8.1 Shutdown and Power-Off



After the system is powered off, the SUN2000 is still energized and hot, which may cause electric shocks or burns. Therefore, wait for at least 15 minutes, wear PPE, and then operate the SUN2000.

- Step 1** Send a shutdown command on the app, SmartLogger, or management system.
For details, see the user manual of the corresponding product.
 - Step 2** Turn off the AC switch between the SUN2000 and the power grid.
 - Step 3** Set the two **DC SWITCH** to **OFF**.
- End

8.2 Power-Off for Maintenance

Context

To prevent personal injury and equipment damage, perform the following procedure to power off the SUN2000 for troubleshooting or replacement.

 **CAUTION**

- If the SUN2000 is faulty, do not stand in front of it if possible.
 - If the LED1 indicator on the SUN2000 is off and the DC switches are **OFF**, do not operate the DC switches. For details, see [Step 4](#).
 - Do not operate the DC switches on the SUN2000 before you perform steps [Step 3](#) to [Step 5](#).
 - When the SUN2000 detects a fault, it triggers automatic DC disconnection protection. Do not turn on the DC switches before the fault is rectified.
 - If the AC switch between the SUN2000 and the power grid has been turned off automatically, do not turn it on before the fault is rectified.
 - Before power-off for maintenance, do not touch the energized components of the SUN2000. Otherwise, electric shocks or arcs may occur.
-

Procedure

- Step 1** Wear proper PPE.
- Step 2** If the SUN2000 does not shut down due to a fault, send a shutdown command on the app, SmartLogger, or management system. If the SUN2000 has shut down due to a fault, go to the next step.
- Step 3** Turn off the AC switch between the SUN2000 and the power grid.
- Step 4** Use a clamp meter to measure the DC current of each PV string input to the SUN2000.
- If the current is less than or equal to 0.5 A, go to the next step.
 - If the current is higher than 0.5 A, wait until the solar irradiance decreases and the PV string current decreases below 0.5 A at night, and then go to the next step.
- Step 5** Open the maintenance compartment door, install a support strut, and use a multimeter to check the voltage between the AC terminal block and the ground. Ensure that the AC side of the SUN2000 is powered off.
- Step 6** Turn off all DC input switches of the SUN2000 and ensure that all switches are **OFF**. If the DC switches are automatically turned off, go to the next step.
- Step 7** Wait for 15 minutes and troubleshoot or repair the SUN2000.

 **WARNING**

- Do not open the panel for maintenance if the SUN2000 is emitting abnormal smell or smoke, or has obvious exceptions.
 - If the SUN2000 does not emit abnormal smell or smoke and is intact, repair or restart it based on the alarm handling suggestions. Do not stand in front of the SUN2000 during the restart.
-

Figure 8-1 Power-off for maintenance

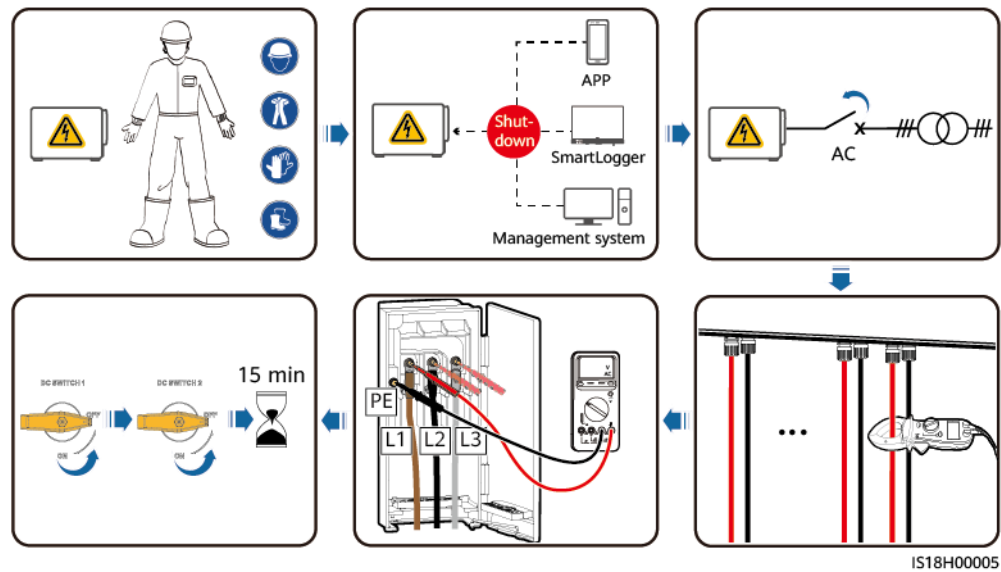

----End

8.3 Routine Maintenance

To ensure that the SUN2000 can operate properly for a long term, you are advised to perform routine maintenance on it as described in this section.

CAUTION

- Before cleaning the SUN2000, connecting cables, and maintaining the grounding reliability, power off the SUN2000 and ensure that the **MAIN SWITCH** and all **DC SWITCH** of the SUN2000 are **OFF**.
- Do not open the maintenance compartment door on rainy or snowy days. If you need to, take protective measures to prevent rain or snow from entering the maintenance compartment. If protective measures cannot be taken, do not open the maintenance compartment door.

Table 8-1 Maintenance checklist

| Check Item | Criteria | Maintenance Interval |
|-----------------------------------|--|---------------------------|
| Cleanness of air inlet and outlet | There is no dust on the air intake and exhaust vents. If necessary, remove the baffle of the air intake vent and clean the dust. | Once every 6 to 12 months |
| Fan | The fans do not produce abnormal sounds during operation. | Once every 6 to 12 months |

| Check Item | Criteria | Maintenance Interval |
|-------------------------------|--|---|
| System running status | <ul style="list-style-type: none"> The SUN2000 is not damaged or deformed. The SUN2000 does not generate abnormal sounds during operation. All SUN2000 parameters are correctly set during operation. | Once every 6 months |
| Electrical connection | <ul style="list-style-type: none"> Cables are securely connected. Cables are intact. In particular, the parts in contact with metallic surfaces are not damaged. The sealing plugs of unused DC input terminals are secured. The unused COM and USB ports are locked by waterproof caps. | 6 months after the first commissioning and once every 6 to 12 months after that |
| Grounding reliability | Ground cables are securely connected. | 6 months after the first commissioning and once every 6 to 12 months after that |
| Vegetation around the SUN2000 | <ul style="list-style-type: none"> Perform inspection and weeding as required. Clean the site promptly after weeding. | Based on the local wilting season |

Figure 8-2 Removing the baffle of the air intake vent

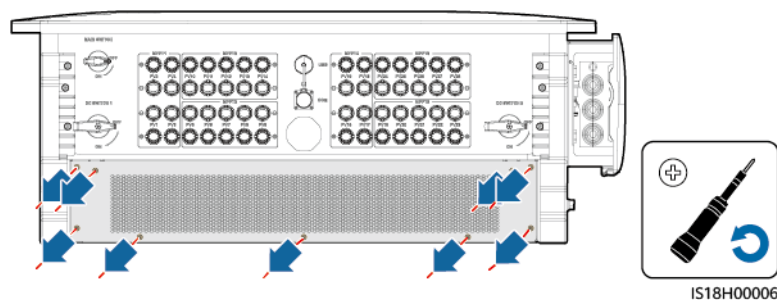

NOTICE

After the cleaning is complete, reinstall the baffle plate. Tighten the M4 screws with a torque of 1.2 N·m.

8.4 Replacing a Fan

CAUTION

- Before replacing a fan, power off the SUN2000.
- When replacing a fan, use insulated tools and wear PPE.

NOTE

If the fan gets stuck when being pulled or pushed, slightly lift it.

Step 1 Remove the fan tray.

1. Remove the screws from the fan tray and store them properly.
2. Pull out the fan tray until the fan baffle plate aligns with the SUN2000 enclosure.
3. Place down the handle.
4. Unscrew the connectors.
5. Disconnect the cables.
6. Pull out the fan tray.

Figure 8-3 Pulling out the fan tray

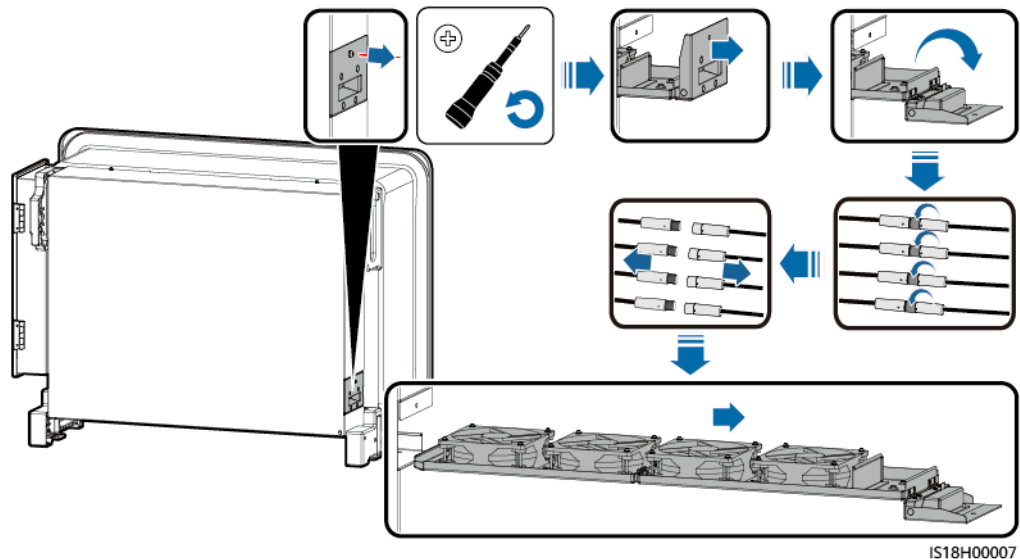

Step 2 Remove the cable ties from the faulty fan.

Figure 8-4 Removing cable ties

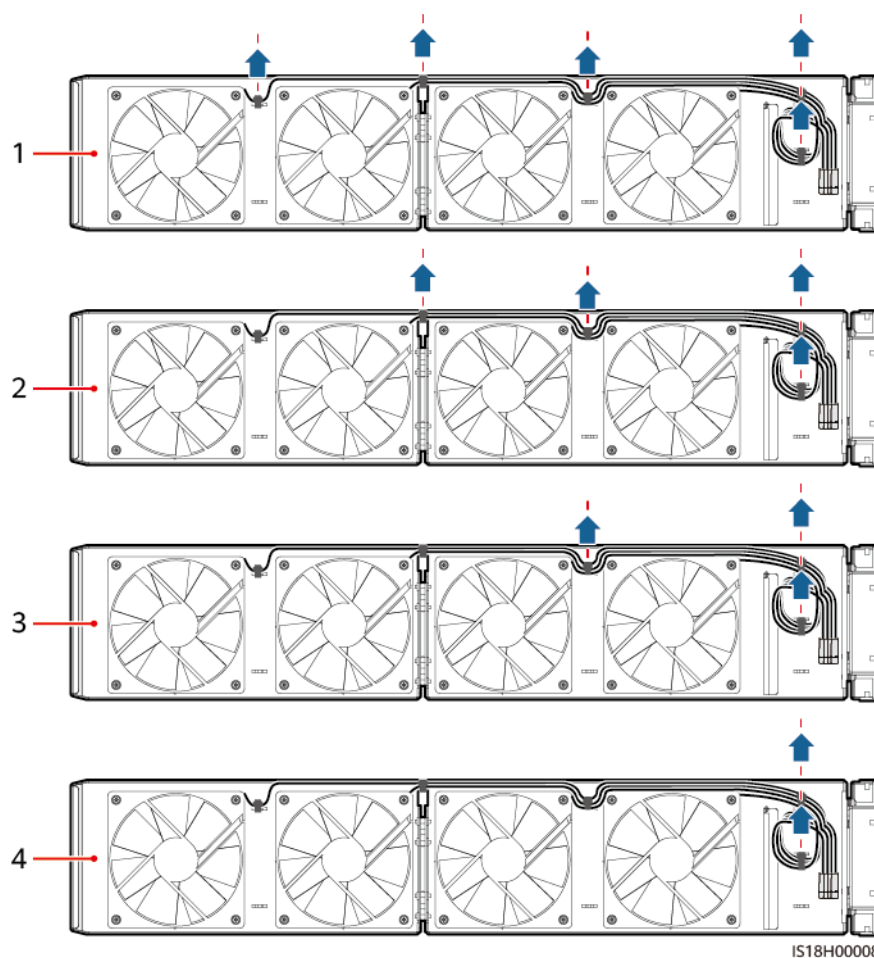

- (1) Remove cable ties from FAN 1.
- (2) Remove cable ties from FAN 2.
- (3) Remove cable ties from FAN 3.
- (4) Remove cable ties from FAN 4.

Step 3 Remove the faulty fan.

Figure 8-5 Removing a fan (using FAN 1 as an example)

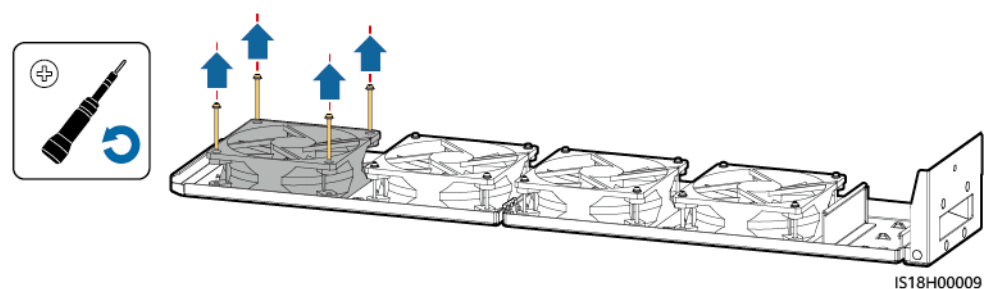

Step 4 Install a new fan.

Figure 8-6 Installing a fan (using FAN 1 as an example)

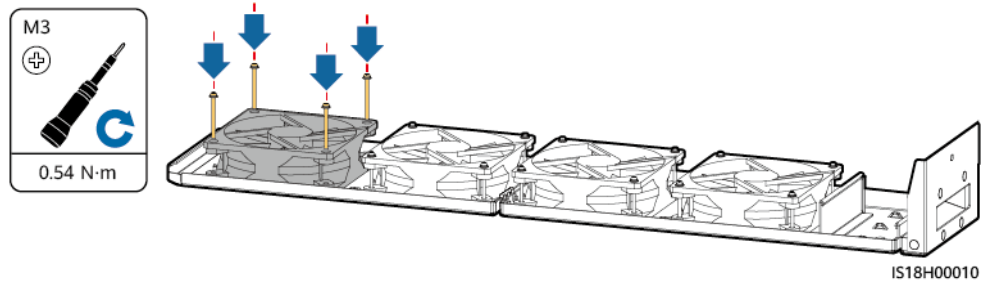

Step 5 Bind the fan cables.

Figure 8-7 Binding cables

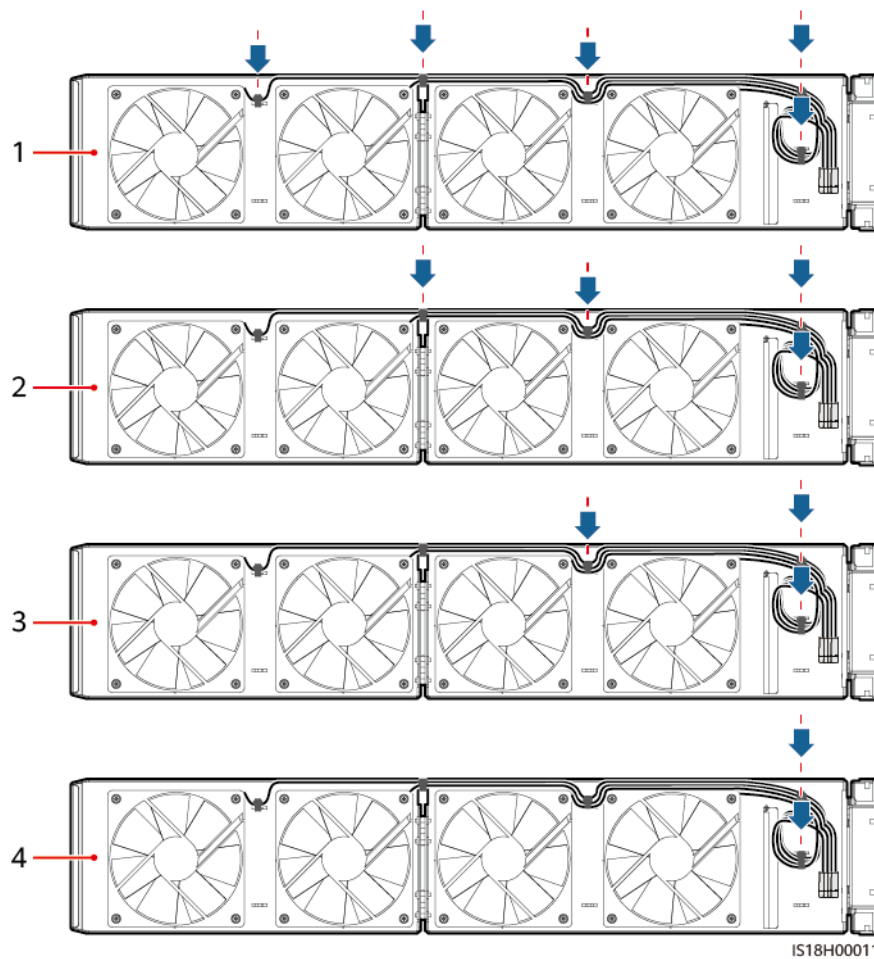

(1) Bind the cables of FAN 1.

(2) Bind the cables of FAN 2.

(3) Bind the cables of FAN 3.

(4) Bind the cables of FAN 4.

Step 6 Install the fan tray.

1. Clean the fan tray and ensure that no foreign matter is left. Align the fan tray with the installation position.
2. Push in the fan tray until the fan baffle plate is flush with the SUN2000 enclosure.

3. Connect the cables correctly according to the cable labels.
4. Rotate the handle.
5. Push the fan tray completely in place.
6. Tighten the screws on the fan tray.

Figure 8-8 Installing a fan tray

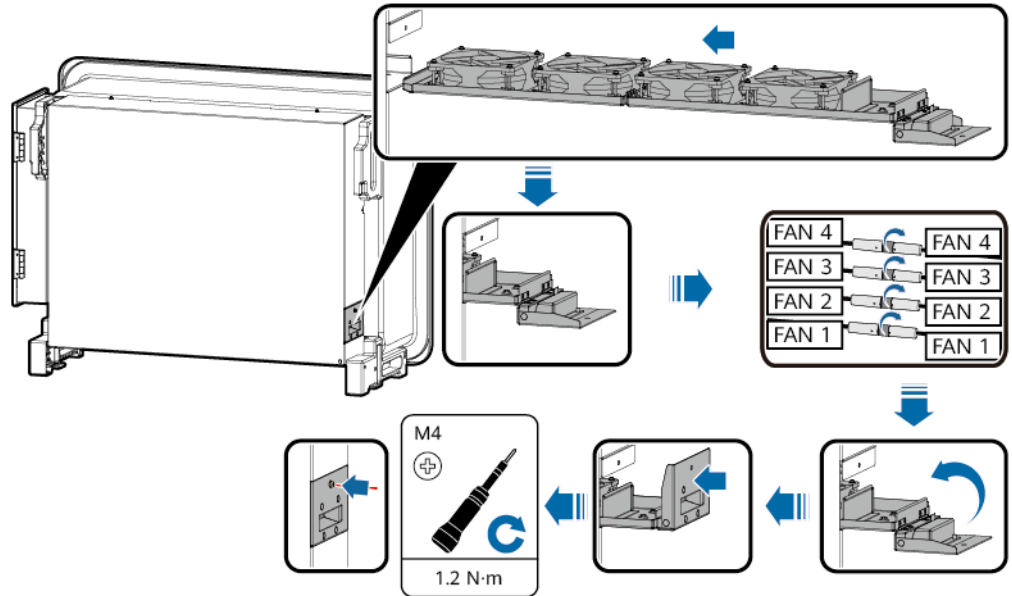

IS18H00012

----End

8.5 Troubleshooting

Alarm severities are defined as follows:

- Major: The inverter is faulty or the external environment is abnormal. As a result, the output power decreases or the inverter stops feeding into the grid.
- Minor alarm: Some components of the inverter are faulty but the inverter can still connect to the grid and generate power.
- Warning: The inverter works properly. The output power decreases or some authorization functions fail due to external factors.

Table 8-2 Common alarms and troubleshooting measures

| Alarm ID | Alarm Name | Alarm Severity | Possible Cause | Suggestion |
|----------|---------------------|----------------|--|---|
| 2001 | High String Voltage | Major | <p>The PV array is not properly configured. Excessive PV modules are connected in series in the PV string, and therefore the PV string open-circuit voltage exceeds the maximum operating voltage of the device.</p> <ul style="list-style-type: none"> • Cause ID = 1: PV1, PV2, PV3, and PV4. • Cause ID = 2: PV5, PV6, PV7, PV8, and PV9. • Cause ID = 3: PV10, PV11, PV12, PV13, and PV14. • Cause ID = 4: PV15, PV16, PV17, and PV18. • Cause ID = 5: PV19, PV20, PV21, PV22, and PV23. • Cause ID = 6: PV24, PV25, PV26, PV27, and PV28. | <p>Check the serial connection configuration of the PV strings in the array and ensure that the PV string open-circuit voltage is not greater than the maximum operating voltage of the device. After the PV array configuration is corrected, the alarm will be automatically cleared.</p> |
| 2003 | DC Arc Fault | Major | <p>Cause ID = 1-28, corresponding to PV1-PV28 respectively.</p> <p>The PV string power cables arced or are in poor contact.</p> | <p>Check whether the string cables arced or are in poor contact.</p> |
| 2010 | Abnormal DC Input | Major | <p>Cause ID = 1 Strings PV1 to PV9 are not connected.</p> <p>Cause ID = 2 The DC SWITCH is OFF.</p> | <p>Cause ID = 1 At least one PV string from PV1 to PV9 is connected.</p> <p>Cause ID = 2</p> <ol style="list-style-type: none"> 1. Turn on the MAIN SWITCH manually. 2. Turn on all DC SWITCH manually. 3. Turn off the MAIN SWITCH manually. 4. If the fault persists, contact your dealer or technical support. |

| Alarm ID | Alarm Name | Alarm Severity | Possible Cause | Suggestion |
|----------|---------------------------|----------------|---|---|
| 2011 | String Reverse Connection | Major | Cause ID = 1-28, corresponding to PV1-PV28 respectively. The PV string is reversely connected. | <ol style="list-style-type: none"> 1. Check whether the PV string is connected to the device in reverse polarity. If yes, wait until the PV string current decreases to below 0.5 A, set DC SWITCH to OFF, and adjust the PV string polarity. 2. If the fault persists, reset the device on the local maintenance app or WebUI of the upper-layer controller. Alternatively, you can turn off the AC and DC switches, wait for 5 minutes, and then turn on the AC and DC switches. |
| 2012 | String Current Backfeed | Warning | Cause ID = 1-28, corresponding to PV1-PV28 respectively. Only a few PV modules are connected in series in the PV string. Therefore, the terminal voltage is lower than that of other PV strings. | <ol style="list-style-type: none"> 1. Check whether the number of PV modules connected in series in this PV string is less than the number of PV modules connected in series in the other PV strings connected in parallel with this PV string. If yes, wait until the PV string current drops to below 0.5 A, set DC SWITCH to OFF, and adjust the number of PV modules in the PV string. 2. Check whether the PV string is shaded. 3. Check whether the open-circuit voltage of the PV string is normal. |
| 2013 | Abnormal String Power | Warning | Cause ID = 1-28, corresponding to PV1-PV28 respectively. <ul style="list-style-type: none"> • The PV string is shaded for a long time. • The PV string has aged abnormally. | <ol style="list-style-type: none"> 1. Check whether the PV string current is obviously lower than the currents of other PV strings. 2. If yes, check whether the PV string is shaded. 3. If the PV string is clean and not shaded, check whether any PV module is faulty. |

| Alarm ID | Alarm Name | Alarm Severity | Possible Cause | Suggestion |
|----------|----------------------------------|----------------|---|---|
| 2014 | High String Voltage to Ground | Major | Cause ID = 1 The string-to-ground voltage is abnormal, which may cause power degradation risks. | <ol style="list-style-type: none"> 1. If no PID compensation device is deployed in the system, disable the PID protection function. Note: If the PID protection function is disabled but the nighttime reactive power compensation is enabled, PV module degradation may occur. 2. If there is a PID compensation device in the system, check whether it is faulty. If yes, rectify the fault. 3. Check whether the device and PID compensation device have consistent compensation direction settings. If not, adjust the settings based on the PV module model. (Note: If the PV- is set to positive offset, the voltage between the PV- of the device and the ground should be greater than 0 V to clear the alarm; if the PV+ is set to negative offset, the voltage between the PV+ of the device and the ground should be less than 0 V to clear the alarm.) 4. If the alarm occurs repeatedly, contact your dealer or technical support. |
| 2015 | PV String Loss | Warning | Cause ID = 1-28, corresponding to PV1-PV28 respectively. <ul style="list-style-type: none"> • A single string is lost. • Both 2-in-1 PV strings are lost. • Either of the 2-in-1 PV strings is lost. | <ol style="list-style-type: none"> 1. Check whether cables are properly connected to the inverter terminals. 2. Check whether cables are properly connected to the PV string terminals. 3. If a 2-in-1 terminal is used, check whether it is normal. 4. If the string connection status is manually configured, check whether the configured status is consistent with the actual connection status. |
| 2031 | Phase Wire Short-Circuited to PE | Major | Cause ID = 1 The phase wire is short-circuited to PE or its impedance to PE is low. | Check the impedance of the phase wire to PE, locate the position with low impedance, and rectify the fault. |

| Alarm ID | Alarm Name | Alarm Severity | Possible Cause | Suggestion |
|----------|-------------------|----------------|--|--|
| 2032 | Grid Loss | Major | Cause ID = 1 <ul style="list-style-type: none"> • The power grid experiences an outage. • The AC circuit is disconnected or the AC circuit breaker is OFF. | <ol style="list-style-type: none"> 1. Check whether the AC voltage is normal. 2. Check whether the AC circuit is disconnected or the AC circuit breaker is OFF. |
| 2033 | Grid Undervoltage | Major | Cause ID = 1 The grid voltage is below the lower threshold or the undervoltage duration exceeds the time that triggers low voltage ride-through (LVRT). | <ol style="list-style-type: none"> 1. If the alarm occurs occasionally, the power grid may be abnormal temporarily. The device automatically recovers after detecting that the power grid becomes normal. 2. If the alarm occurs frequently, check whether the power grid voltage is within the allowed range. If no, contact the local power operator. If yes, modify the power grid undervoltage protection threshold after obtaining the consent of the local power operator. 3. If the fault persists for a long time, check the connection between the AC switch and power cables. |
| 2034 | Grid Overvoltage | Major | Cause ID = 1 The grid voltage exceeds the higher threshold or the high voltage has lasted for more than the value specified by high voltage ride-through (HVRT). | <ol style="list-style-type: none"> 1. If the alarm occurs occasionally, the power grid may be abnormal temporarily. The device automatically recovers after detecting that the power grid becomes normal. 2. If the alarm occurs frequently, check whether the power grid voltage is within the allowed range. If no, contact the local power operator. If yes, modify the power grid overvoltage protection threshold after obtaining the consent of the local power operator. 3. Check whether the peak voltage of the power grid is too high. If the fault occurs frequently and persists for a long time, contact the local power operator. |

| Alarm ID | Alarm Name | Alarm Severity | Possible Cause | Suggestion |
|----------|------------------------|----------------|---|--|
| 2035 | Grid Voltage Imbalance | Major | Cause ID = 1 The difference between grid phase voltages exceeds the upper threshold. | <ol style="list-style-type: none"> 1. If the alarm occurs occasionally, the power grid may be abnormal temporarily. The device automatically recovers after detecting that the power grid becomes normal. 2. If the alarm occurs frequently, check whether the power grid voltage is within the normal range. If no, contact the local power operator. 3. If the fault persists for a long time, check the connection of the AC cables. 4. If the AC cables are correctly connected and the alarm persists and affects the operation of the plant, contact the local power operator. |
| 2036 | Grid Overfrequency | Major | Cause ID = 1 Power grid exception: The power grid frequency is higher than the frequency required in the local standard. | <ol style="list-style-type: none"> 1. If the alarm occurs occasionally, the power grid may be abnormal temporarily. The device automatically recovers after detecting that the power grid becomes normal. 2. If the alarm occurs frequently, check whether the power grid frequency is within the allowed range. If not, contact the local power operator. If yes, modify the power grid overfrequency protection threshold after obtaining the consent of the local power operator. |

| Alarm ID | Alarm Name | Alarm Severity | Possible Cause | Suggestion |
|----------|-------------------------|----------------|--|---|
| 2037 | Grid Underfrequency | Major | Cause ID = 1 Power grid exception: The actual power grid frequency is lower than the standard requirement for the local power grid. | <ol style="list-style-type: none"> 1. If the alarm occurs occasionally, the power grid may be abnormal temporarily. The device automatically recovers after detecting that the power grid becomes normal. 2. If the alarm occurs frequently, check whether the power grid frequency is within the allowed range. If not, contact the local power operator. If yes, modify the power grid underfrequency protection threshold after obtaining the consent of the local power operator. |
| 2038 | Unstable Grid Frequency | Major | Cause ID = 1 Power grid exception: The actual grid frequency change rate does not comply with the local power grid standard. | <ol style="list-style-type: none"> 1. If the alarm occurs occasionally, the power grid may be abnormal temporarily. The device automatically recovers after detecting that the power grid becomes normal. 2. If the alarm occurs frequently, check whether the power grid frequency is within the allowed range. If not, contact the local power operator. |
| 2039 | AC Overcurrent | Major | Cause ID = 1 The grid experiences a dramatic voltage drop or is short-circuited. As a result, the transient AC current of the device exceeds the upper threshold and triggers protection. | <ol style="list-style-type: none"> 1. The device detects its external working conditions in real time. After the fault is rectified, the device automatically recovers. 2. If the alarm occurs frequently and affects the operation of the power plant, check whether AC short circuit exists. If the fault persists, contact your dealer or technical support. |
| 2040 | DC Component Overhigh | Major | Cause ID = 1 The DC component in the AC current exceeds the upper threshold. | <ol style="list-style-type: none"> 1. The device detects its external working conditions in real time. After the fault is rectified, the device automatically recovers. 2. If the alarm occurs frequently, contact your dealer or technical support. |

| Alarm ID | Alarm Name | Alarm Severity | Possible Cause | Suggestion |
|----------|------------------------------------|----------------|---|---|
| 2051 | Abnormal Residual Current | Major | Cause ID = 1 The ground insulation resistance decreases during device operation. | <ol style="list-style-type: none"> If the alarm occurs occasionally, the external circuit may be abnormal temporarily. The device will automatically recover after the fault is rectified. If the alarm occurs frequently or persists, check whether the DC-to-ground impedance is too low. |
| 2062 | Low Insulation Resistance | Major | Cause ID = 1 <ul style="list-style-type: none"> A short circuit occurs between the PV array and the ground. The ambient air of the PV array is damp and the insulation between the PV array and the ground is poor. | <ol style="list-style-type: none"> Set Insulation resistance protection to the minimum value and restart the inverter. Check that the PE cable of the device is correctly connected. Check the output impedance of the PV array to ground. If there is a short circuit or lack of insulation, rectify it. |
| 2063 | Overtemperature | Minor | Cause ID = 1 <ul style="list-style-type: none"> The device is installed in a place with poor ventilation. The ambient temperature is higher than the upper threshold. The device is faulty. | <ol style="list-style-type: none"> Check the ventilation and ambient temperature of the device installation position. If the ventilation is poor or the ambient temperature exceeds the upper threshold, improve the ventilation and heat dissipation. If the ventilation and ambient temperature meet requirements, contact your dealer or technical support. |
| 2064 | Device Fault | Major | Cause ID = 1-12, 20 A major fault has occurred on a circuit inside the device. | Cause ID = 1-12 Turn off the AC and DC switches, wait for 5 minutes, and then turn on the AC and DC switches. If the fault persists, contact your dealer or technical support. Cause ID = 20 Do not turn off the AC output switch or DC input switch. Contact your dealer or technical support. |
| 2065 | Upgrade Failed or Version Mismatch | Minor | Cause ID = 1-4, 7 The upgrade ends abnormally. | <ol style="list-style-type: none"> Perform an upgrade again. If the upgrade fails for multiple times, contact your dealer or technical support. |

| Alarm ID | Alarm Name | Alarm Severity | Possible Cause | Suggestion |
|----------|-----------------------------|----------------|--|---|
| 2066 | License Expired | Warning | Cause ID = 1 1. The license has entered the grace period. 2. The license is about to expire. | 1. Apply for a new license certificate. 2. Load the new license certificate. |
| 2086 | Abnormal External Fan | Major | Cause ID = 1-4, corresponding to external fans FAN1-FAN4. The external fan is short-circuited, the power supply is insufficient, or the air channel is blocked. | 1. Turn off the AC and DC switches, check whether the fan blades are damaged, and clear the foreign matter around the fan. 2. Reinstall the fan and turn on the AC and DC switches. If the fault persists after the device runs for 15 minutes, replace the external fan. |
| 2087 | Abnormal Internal Fan | Major | Cause ID = 1 and 2, corresponding to internal fans FAN1 and FAN2. The internal fan is short-circuited, the power supply is insufficient, or the fan is damaged. | Turn off the AC and DC switches, wait for 5 minutes, and then turn on the AC and DC switches. If the fault persists after the device runs for 5 minutes, contact your dealer or technical support to replace the device. |
| 2088 | Abnormal DC Protection Unit | Major | Cause ID = 3 The contact points of the DC switches are stuck. | 1. If the DC indicator on the panel is off, contact your dealer or technical support to replace the device. 2. If the DC indicator on the panel is on, wait until the PV string current decreases to below 0.5 A, turn off the AC switch and DC switch, wait for 5 minutes, and then turn on the AC switch and DC switch. If the fault persists after the device runs for 5 minutes, contact your dealer or technical support. |
| 2093 | Abnormal DC Switches | Minor | Cause ID = 1 The DC switch is not in the ON position, or the DC switch reset button is not pressed down to the bottom. | Check whether all DC switches are in the ON position. If not, turn the switches to the ON position (you can rotate the switches with force to ensure that they are in position). If the switches still cannot be turned to the ON position, press the reset buttons of all DC switches inwards until they cannot go further, and then turn on the DC switches again. |

| Alarm ID | Alarm Name | Alarm Severity | Possible Cause | Suggestion |
|----------|--|----------------|---|---|
| 2099 | Local Access Certificate Invalid | Warning | Cause ID = 1 The digital signature certificate is invalid. | Check the time or replace the digital signature certificate. |
| 2100 | Local Access Certificate About to Expire | Warning | Cause ID = 1 The digital signature certificate is about to expire. | Replace the digital signature certificate in time. |
| 2101 | Local Access Certificate Expired | Major | Cause ID = 1 The digital signature certificate has expired. | Replace the digital signature certificate immediately. |
| 2102 | Protection upon Communication Failure | Warning | Cause ID = 1 When the communication disconnection duration exceeds the specified threshold, the device starts the protection function. | <ol style="list-style-type: none"> 1. If the fault occurs occasionally, the device recovers to the normal state after receiving a scheduling command. No manual intervention is required. 2. Manually deliver a power scheduling command. 3. If the Protection upon Communication Failure function is not required, disable it. |
| 61440 | Monitoring Unit Faulty | Minor | Cause ID = 1 <ul style="list-style-type: none"> • The flash memory is insufficient. • The flash memory has bad sectors. | Turn off the AC and DC switches, wait for 5 minutes, and then turn on the AC and DC switches. If the fault persists, replace the monitoring board or contact your dealer or technical support. |

9 Handling the Inverter

9.1 Removing the SUN2000

NOTICE

Before removing the SUN2000, disconnect both AC and DC connections.

Perform the following operations to remove the SUN2000:

1. Disconnect all cables from the SUN2000, including RS485 communications cables, DC input power cables, AC output power cables, and PGND cables.
2. Remove the SUN2000 from the mounting bracket.
3. Remove the mounting bracket.

9.2 Packing the SUN2000

- If the original packing materials are available, put the SUN2000 inside them and then seal them by using adhesive tape.
- If the original packing materials are not available, put the SUN2000 inside a suitable cardboard box and seal it properly.

9.3 Disposing of the SUN2000

If the SUN2000 service life expires, dispose of it according to the local disposal rules for electrical equipment waste.

10 Technical Specifications

Efficiency

| Item | SUN2000-330KTL-H1 | SUN2000-330KTL-H2 |
|---------------------|-------------------|-------------------|
| Maximum efficiency | ≥ 99.0% | |
| European efficiency | ≥ 98.8% | |

Input

| Item | SUN2000-330KTL-H1 | SUN2000-330KTL-H2 |
|---|-------------------|-------------------|
| Maximum input voltage | 1500 V | |
| Maximum input current (per MPPT) | 65 A | |
| Maximum short-circuit current (per MPPT) | 115 A | |
| Minimum operating voltage/startup voltage | 500 V/550 V | |
| MPP voltage range | 500–1500 V | |
| Rated input voltage | 1080 V | |
| Number of inputs | 28 | |
| Number of MPPTs | 6 | |

Output

| Item | SUN2000-330KTL-H1 | SUN2000-330KTL-H2 |
|--------------------|-------------------|-----------------------|
| Rated output power | 300 kW | 275 kW ^[1] |

| Item | SUN2000-330KTL-H1 | SUN2000-330KTL-H2 |
|---|-----------------------------|-----------------------------|
| Maximum apparent power | 330 kVA | 330 kVA |
| Maximum active power (cos ϕ = 1) | 330 kW | 330 kW |
| Rated output voltage | 800 V AC, 3W+PE | 800 V AC, 3W+PE |
| Rated output current | 216.6 A | 198.5 A ^[1] |
| Adapted power grid frequency | 50 Hz/60 Hz | 50 Hz/60 Hz |
| Maximum output current | 238.2 A | 240.3 A |
| Power factor | 0.8 leading and 0.8 lagging | 0.8 leading and 0.8 lagging |
| Maximum total harmonic distortion (rated power) | < 1% | < 1% |
| Note [1]: The ambient temperature is 50°C. | | |

Protection

| Item | SUN2000-330KTL-H1 | SUN2000-330KTL-H2 |
|---|-------------------|-------------------|
| Input DC switch | Supported | |
| Anti-islanding protection | Supported | |
| Output overcurrent protection | Supported | |
| Input reverse connection protection | Supported | |
| PV string fault detection | Supported | |
| DC surge protection | Type II | |
| AC surge protection | Type II | |
| Insulation resistance detection | Supported | |
| Residual current monitoring unit (RCMU) | Supported | |

Display and Communication

| Item | SUN2000-330KTL-H1 | SUN2000-330KTL-H2 |
|----------|-------------------|-------------------|
| Display | LED indicators | |
| RS485 | Supported | |
| MBUS | Supported | |
| USB | Supported | |
| WLAN+App | Supported | |

General Specifications

| Item | SUN2000-330KTL-H1 | SUN2000-330KTL-H2 |
|--|---|-------------------|
| Dimensions (W x H x D) | 1048 mm x 732 mm x 395 mm | |
| Net weight | 112 kg | |
| Operating temperature | -25°C to +60°C | |
| Cooling mode | Smart air cooling | |
| Maximum operating altitude | 5000 m (derated when the altitude is greater than 4000 m) | |
| Relative humidity | 0%-100% RH | |
| Input terminal | HH4SFD4TMS/HH4SMD4TMS | |
| Output terminal | Waterproof terminal+OT/DT terminal | |
| IP rating | IP66 | |
| Self power consumption at night (sleep mode) | 4.8 W | |

A Domain Name List of Management Systems

 NOTE

The list is subject to change.

Table A-1 Domain names of management systems

| Domain Name | Data Type | Scenario |
|-----------------------------|-------------------|--|
| intl.fusionsolar.huawei.com | Public IP address | FusionSolar hosting cloud NOTE The domain name is compatible with cn.fusionsolar.huawei.com (Chinese mainland). |

B Contact Information

If you have any questions about this product, please contact us.

Table B-1 Customer service contact information

| Region | Country | Email | Tel |
|--------------|-----------------|--------------------------------|-------------------------------------|
| Europe | France | eu_inverter_support@huawei.com | 0080033888888 |
| | Germany | | |
| | Spain | | |
| | Italy | | |
| | United Kingdom | | |
| | Netherlands | | |
| | Other countries | | |
| Asia-Pacific | Australia | eu_inverter_support@huawei.com | 1800046639 |
| | Turkey | eu_inverter_support@huawei.com | - |
| | Malaysia | apsupport@huawei.com | 0080021686868 /1800220036 |
| | Thailand | | (+66) 26542662 (local rate call) |
| | | | 1800290055 (free in Thailand) |
| | China | solarservice@huawei.com | 400-822-9999 |
| | Other countries | apsupport@huawei.com | 0060-3-21686868 |

| Region | Country | Email | Tel |
|------------------------|-------------------|--------------------------------|-----------------------------------|
| Japan | Japan | Japan_ESC@ms.huawei.com | 0120258367 |
| India | India | indiaenterprise_TAC@huawei.com | 1800 103 8009 |
| Republic of Korea | Republic of Korea | Japan_ESC@ms.huawei.com | - |
| North America | United States | eu_inverter_support@huawei.com | 1-877-948-2934 |
| | Canada | eu_inverter_support@huawei.com | 1-855-482-9343 |
| Latin America | Mexico | la_inverter_support@huawei.com | 018007703456 /0052-442-4288288 |
| | Argentina | | 0-8009993456 |
| | Brazil | | 0-8005953456 |
| | Chile | | 800201866 (fixed-line only) |
| | Other countries | | 0052-442-4288288 |
| Middle East and Africa | Egypt | eu_inverter_support@huawei.com | 08002229000 /0020235353900 |
| | UAE | | 08002229000 |
| | Southern Africa | | 0800222900 |
| | Saudi Arabia | | 8001161177 |
| | Pakistan | | 0092512800019 |
| | Morocco | | 0800009900 |
| | Other countries | | 0020235353900 |

 **NOTE**

EU Representative Information: Huawei Technologies Hungary Kft.
Add.: HU-1133 Budapest, Váci út 116-118., 1. Building, 6. floor.
Email: hungary.reception@huawei.com

C Acronyms and Abbreviations

L

LED light emitting diode

M

MBUS monitoring bus

MPP maximum power point

MPPT maximum power point tracking

P

PID potential induced degradation

PV photovoltaic

R

RCMU residual current monitoring unit